

SCARVES, HATS, STOCKING STUFFERS! STITCH EVERYTHING ON YOUR LIST  
COOL FASHION: GORGEOUS WINTER WHITES TO CHASE AWAY THE CHILL

BE CREATIVE YOUR WAY

NOVEMBER/DECEMBER 2009

# crochet

today!

**DECK  
THE HALLS!**

Retro-Inspired Holiday Decor

**SWEET  
TREATS**

Yummy Designs For  
**KIDS & BABY**

**PLUS** • Sweaters • Afghans

**20+**  
FUN GIFTS  
GET STARTED  
NOW!

Future +  
MEDIA WITH PASSION

70989 3879 1 75

0 70989 3879 1 75

#7.99US

Visit us online for free patterns, how-tos and our <http://madam.sytes.net>





## Regular Features



**ON THE COVER**  
Crochet under the tree! Stitch our kitschy tree skirt, the Retro Ripples Skirt, in Red Heart Holiday. Find the pattern on page 26.

**6**  
**Editor's Letter**  
Tons of inspiration for handmade holidays.

**7**  
**Reader Mail**  
Feedback and great projects from our readers.

**8**  
**Products & News**  
Stocking stuffers, new yarn, and more goodies you have to have.

**10**  
**People**  
This charity gets in the spirit of the season.

**11**  
**Crochet Doctor**  
How to make something for everyone on your list, plus extended stitches.

**14**  
**Vintage Crochet**  
An old Christmas ornament made new!

**18**  
**Crochet Class**  
Helpful tips from crochet expert Lily Chin.

**20**  
**Reading**  
Great new volumes for your bookshelf.

**89**  
**Resources**  
Helpful info and more.

**92**  
**Stitch in Time**  
One dress, three generations.

**93**  
**Adventures in Crochet**  
The tasty side of craft: Crocheting with food!

**94**  
**Projects in This Issue**  
A helpful photo index.

### FOR OUR OVERSEAS READERS:

U.S. crochet terms may vary from those used in Australia and the U.K. Turn to page 91 for a list of translations.





## November/December 2009 Designs

### HOLIDAY DECOR: 21

22 **Stitchy Gingerbread House**  
No baking required!

26 **Retro Ripples Skirt**  
Dress up your tree in this sparkly retro skirt.

30 **Candy Shop Ornaments**  
Ribbon candy, candy canes, and peppermints for the tree

34 **Sparkly Snowflakes**  
A cozy and festive wintry afghan.

37 **Stuffable Stockings**  
Fill these up with lots of presents!

40 **Little Drummer Set**  
A soft drum and cymbal set for home marching bands.

### WINTER FASHION: 43

44 **Icicles Pullover**  
Bold diagonal lace spirals around this pullover.

50 **Snowfall Cowl**  
A fuzzy little neckwarmer.

52 **Capelet Swing Cardi**  
Heads will turn when you wear this striking coat.

56 **Snowflake Earrings**  
Wear these delicate, pretty earrings to your next holiday party.



### KIDS & BABY: 59

60 **Candyland Sweater**  
Work this cardigan from the top down and test its fit as you go.

66 **Cotton Candy Blanket**  
Soft, fluffy yarn makes for a delectable blanket.

70 **Gumdrop Booties**  
A sweet pair of baby booties for up to 3 sizes.

72 **Candy Store Set**  
A matching scarf and mitten set to keep kids warm on winter days.



### HOLIDAY GIFTS: 75

76 **Twirly Scarf**  
This simple pattern creates cascading spirals; no one will know how easy it was!

78 **Two-Hour Hat**  
A quick cap for the man on your list.

80 **Snuggly Slippers**  
No one likes cold toes; give friends these cozy slippers!

83 **Giftly Gloves**  
Fingerless gloves in variegated yarn allow you to work with warm hands.

86 **Wrap-Up Afghan**  
Gift-wrap this blanket of granny squares.





BEFORE:  
1980

AFTER:  
2007



# Have a Ball

We remake a starched ornament from the archives with gorgeous, modern results.

By Kj Hay

Think starched crochet has fallen out of vogue? So did we, until we saw this holiday ornament in our archives and knew it would make a stunning decoration for today's homes. To update it, we used a sugar and water solution to stiffen it instead of starch, which can tend to yellow over time. We think this is one classic ornament that's guaranteed to be treasured for years to come.

## What You'll Need

### YARN

AUNT LYDIA'S Fashion Crochet Thread, Size 3, each ball approx. 150yd/137m (cotton)

- 2 balls #201 White

**Note** You are likely to need only a small amount of the 2nd ball. If you work tighter than the given gauge, you may be able to make one ornament from a single ball of thread.

### CROCHET HOOK

- Size G/2 (2.75mm) crochet hook or any size to obtain correct gauge

### NOTIONS

- 1 cup of sugar (for stiffening)
- 1 small round balloon
- 24"/61cm length of 1½"/4cm wide gold wire-edged ribbon (or any desired ribbon)
- Yarn needle

Skill Level: Intermediate

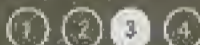

## the yarn

Fashion Crochet Thread  
Size 3 in White

## FINISHED MEASUREMENTS

Approx 5¾"/13.5cm diameter

## GAUGE

Motif = 3¾"/9.5cm across widest point  
*Gauge is not critical for this project.*

## ORNAMENT

### Motif (Make 12)

Make an adjustable ring.

**Round 1** (right side) Ch 4 (counts as dc and ch-1 sp), [dc in ring, ch 1] 9 times; join with sl st in 3rd ch of beginning ch-4—10 dc and 10 ch-1 sps.

**Round 2** Ch 1, sc in same ch as joining, [ch 5, sc in next dc] 9 times; join with ch 2; dc in first sc (join counts as a ch-5 sp)—10 sc and 10 ch-5 sps.

**Round 3** Ch 1, (sc, ch 3, 3 sc) in first ch-5 sp (around post of joining dc), [(3 sc, ch 3, 3 sc) in next ch-5 sp] 9 times, 2 sc in first ch-5 sp (in ch-2 sp before dc); join with sl st in first sc—60 sc and 10 ch-3 sps.

**Round 4** (Sl st, ch 1, sc) in first ch-3 sp, ch 4, dc in next ch-3 sp, ch 4, [sc in next ch-3 sp, ch 4, dc in next ch-3 sp, ch 4] 4 times; join with sl st in first sc—5 sc, 5 dc and 10 ch-4 sps.

**Round 5** Ch 3 (counts as dc), \*dc in next 4 chs, (dc, ch 3, dc) in next dc, dc in next 4 chs\*\*, dc in next sc; repeat from \* 4 more times, ending last repeat at \*\*; join with sl st

## ABBREVIATIONS USED IN THIS PATTERN

ch(s) chain(s)      sl st slip stitch  
dc double crochet      sp(s) space(s)  
sc single crochet      st(s) stitch(es)

[ ] Work directions inside brackets as many times as indicated.

() Work directions inside parentheses into stitch or space indicated.

\* Repeat directions following \* as many times as indicated.

## SPECIAL TECHNIQUE

**adjustable ring method** Holding the thread a few inches from the end, wrap around your finger. Do not remove wrap from finger, insert hook into the wrap and draw up a loop of working thread. Chain one to secure the loop and remove ring from finger. Work stitches of first round in the ring. Pull gently, but firmly, on tail to tighten ring.

in 3rd ch of beginning ch-3—55 dc and 5 corner ch-3 sps. Fasten off, leaving a long tail for sewing motifs together. Weave in beginning tail.

## ASSEMBLY

Arrange 6 motifs as shown in assembly diagram, with one motif surrounded by 5 motifs. Holding wrong sides of motifs together and sewing through back loops only, sew one edge of each of 5 surrounding motifs to one edge of center motif, starting and ending in center ch of each corner ch-3 sp. Then sew side edges of 5 motifs together in same manner. Sew remaining 6 motifs together in same manner. Sew two halves of ornament together, in same manner, along 2 unjoined edges of each of 5 motifs on each half, staggering motifs. Weave in any remaining ends.



SCHEMATIC

STIFFENING

Combine 1 cup of sugar and ½ cup of water in a heavy saucepan and heat slowly. Stir constantly until sugar dissolves and mixture is clear. Remove saucepan from heat and allow mixture to cool until comfortable to touch. Immerse ornament in sugar mixture and allow mixture to be absorbed into thread. Remove soaked ornament from mixture. Gently squeeze and wipe off excess stiffening mixture (do not twist ornament). Insert balloon through any opening in ornament and inflate until ornament is desired shape. Thread a long length of string through any opening in ornament and hang ornament to dry over a dish (for catching any drips). Allow ornament to dry thoroughly. Drying time can vary greatly depending on weather conditions. It can take 3 or more days for ornament to dry and stiffen completely. When ornament is dry, pop and remove balloon.

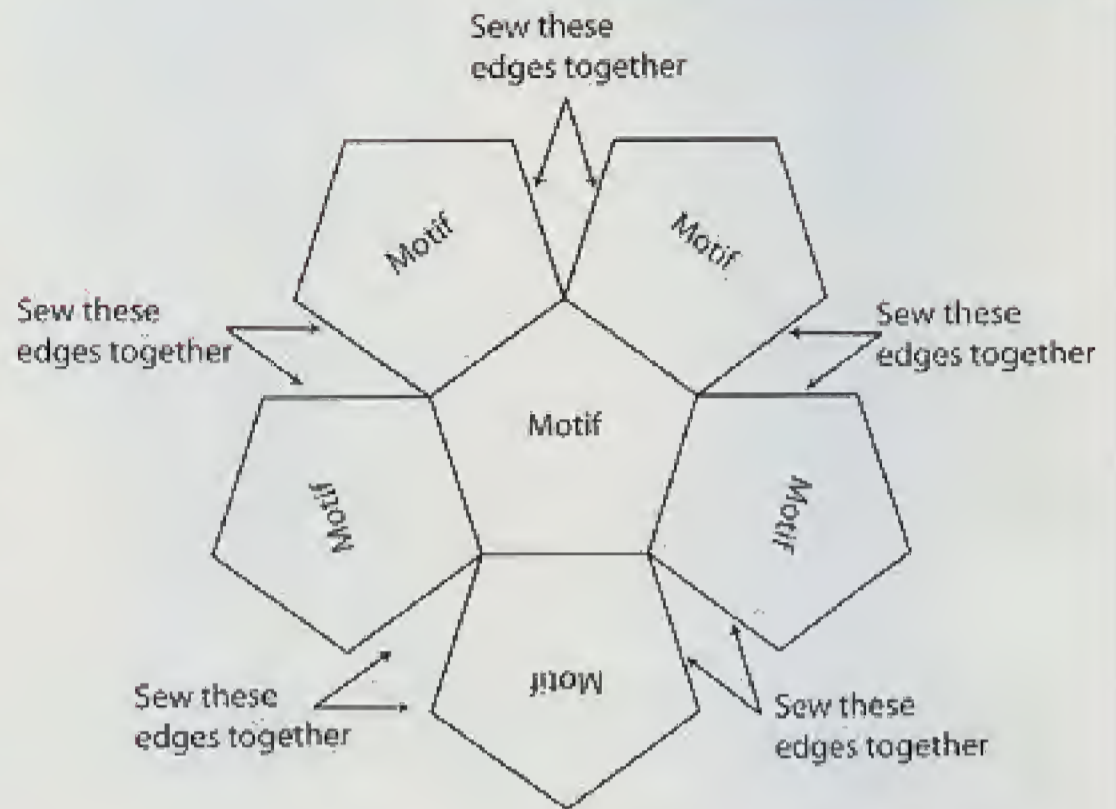

FINISHING

Insert ribbon through any opening in ornament and tie ends in a bow to hang.

STITCH DIAGRAM

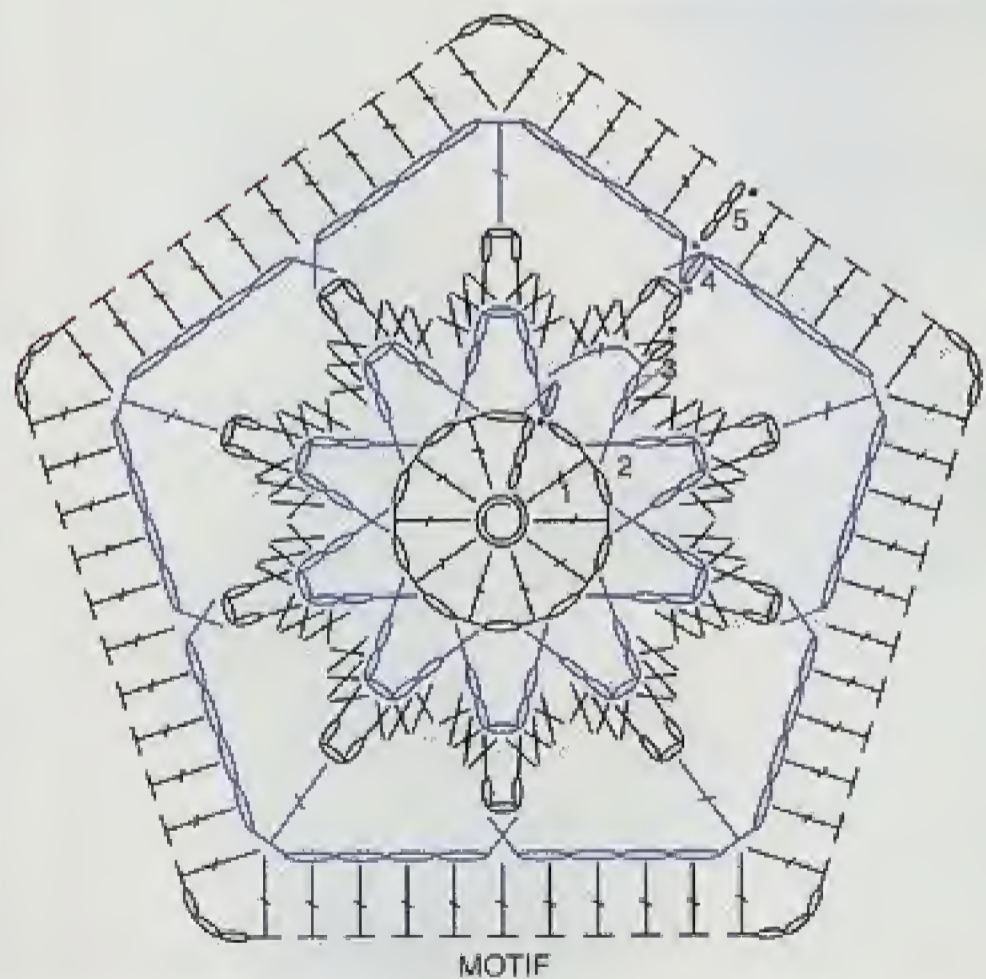

Tip

Make the motifs look like poinsettias by working Round 1 with green thread, Rounds 2 and 3 with red thread, and Rounds 4 and 5 with white thread.



# Deck the Halls

**A**dd a vintage touch to your home this holiday season with patterns that are a blast from the past. Our stockings, ornaments, tree skirt and more give a nod to the past while lending a fabulous flair to your decor today. Cheers!



Stitchy tree skirt P26



# Stitchy Gingerbread House

Why toil in the kitchen when you can *crochet* a sweet old-fashioned treat? Crocheted candies and “frosting” decorate this delightfully kitschy holiday house—best of all, it will last for years to come.

By Carolyn Christmas



Super Saver in Café

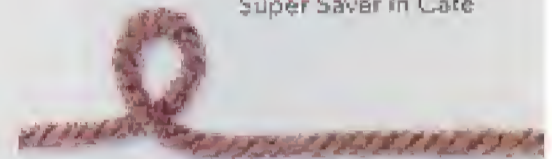

## What You'll Need

### YARN

RED HEART Super Saver, 7oz/198g skeins, each approx 364yd/333m (acrylic)

1 skein each:

- #300 Café (A)
- #316 Soft White (B)
- #380 Hot Red (C)
- #368 Paddy Green (D)
- #324 Bright Yellow (E)
- #579 Pale Plum (F)
- #373 Petal Pink (G)

**Note** Only small amounts of colors C, D, E, F, and G are needed.

### CROCHET HOOK

- Size 5/6 (4mm) crochet hook or any size to obtain correct gauge

### NOTIONS

- Medium-weight cardboard (such as a medium-weight cardboard box)
- Box cutter or other blade for cutting cardboard
- Wide cellophane or packing tape—about 2" (5cm) wide
- Ruler
- Graph paper (optional, but useful as a tool to help create straight lines and angles for cutting cardboard pieces)
- Straight pins
- Glue gun and glue sticks
- Stitch markers
- Yarn needle

Skill Level: Easy



## ABBREVIATIONS USED IN THIS PATTERN

ch chain                      sk skip  
dc double crochet        sl st slip stitch  
sc single crochet        st(s) stitch(es)

[ ] Work directions in brackets number of times indicated.

\* Repeat directions following \* as many times as indicated.

## SPECIAL ABBREVIATION

**sc2tog** (single crochet 2 stitches together) [Insert hook in next st, yarn over and draw up a loop] twice, yarn over and draw through all 3 loops on hook.

## FINISHED MEASUREMENTS

Approx 8½ x 8½ x 8½"/21.5 x 21.5 x 21.5cm

## GAUGE

16 sts and 16 rows = 4"/10cm over single crochet.

*Gauge is not critical for this project.*

## HOW TO MAKE A GAUGE SWATCH

Ch 17.

**Row 1** Sc in 2nd ch from hook and in each remaining ch across—16 sc.

**Rows 2–16** Ch 1, turn; sc in each sc across. Resulting gauge swatch should measure approx 4 x 4"/10 x 10cm; if necessary, adjust hook size to obtain correct gauge.

## NOTES

1 The gingerbread house is made by crocheting pieces, attaching the crocheted pieces

to a cardboard frame, then embellishing with crocheted trims.

2 The cardboard is cut using the crocheted pieces as a pattern, so exact gauge is not critical. However, you want a firm crochet fabric.

## FRONT

With A, ch 25.

**Row 1** Sc in 2nd ch from hook and in each remaining ch across—24 sc.

**Rows 2–13** Ch 1, turn; sc in each sc across. Place a marker at the beginning and end of Row 13.

**Rows 14 and 15** Ch 1, turn; sk first sc, sc in each sc across to last 2 sc, sc2tog—20 sc.

**Row 16** Ch 1, turn; sc in each sc across.

**Rows 17–19** Repeat Rows 14–16—16 sc.

**Rows 20–23** Repeat Row 14, 4 times—8 sc.

**Row 24** Ch 1, turn; sc in each sc across.

**Rows 25–27** Repeat Row 14, 3 times—2 sc.

**Row 28** Ch 1, turn; sc in each sc across.

**Row 29** Ch 1, turn; sc2tog.

**Edging Round** Ch 1, turn; 3 sc in sc; working around all edges, sc in the end of each row and in each st around, working 3 sc in each end of Row 13 (marked) and in each lower corner; join with sl st in first sc. Fasten off.

## BACK

Make same as front.

## SIDE (MAKE 2)

With A, ch 25.

**Row 1** Sc in 2nd ch from hook and in each remaining ch across—24 sc.







**Rows 2–13** Ch 1, turn; sc in each sc across.  
**Edging Round** Ch 1, turn; 3 sc in first sc; sc in each sc across to last sc, 3 sc in last sc; working along edges, sc in the end of each row and in each st around, working 3 sc in each lower corner; join with sl st in first sc. Fasten off.

**ROOF**

**First Half**

With A, ch 32.

**Row 1** (right side) Sc in 2nd ch from hook, [sk next 2 ch, 5 dc in next ch (shell made), sk next 2 ch, sc in next ch] 5 times—5 shells.

**Row 2** Ch 3, turn; working in front loops only, 2 dc in first sc, [sc in center dc of next shell, shell in next sc] 4 times, sc in center dc of next shell, 3 dc in last sc.

**Row 3** Ch 1, turn; working in back loops only, sc in first dc, [shell in next sc, sc in center dc of next shell] 4 times, shell in next sc, sc in top of turning ch.

**Rows 4–10** Repeat Rows 2 and 3 three times, then repeat Row 2 once more. Fasten off.

**Second Half**

**Row 1** With right side facing and working along opposite side of foundation ch of first half of roof, join A with sc in first ch, [sk next 2 ch, shell in next ch, sk next 2 ch, sc in next ch] 5 times—5 shells.

**Rows 2–10** Work Rows 2–10 of first half of roof. Fasten off.

**Snow Trim**

With right side facing and working in free loops of Row 1 of one half of roof, join B with sc in first st, sc in next 2 sts, 3 sc in center dc of next shell, [sc in next 5 sts across to center dc of next shell, 3 sc in center dc of next shell] 4 times, sc in last 3 sts. Fasten off. Repeat on Row 1 of other half of roof. Repeat snow trim on Rows 3, 5, 7, and 9 on both halves of roof.

**Edging**

With right side facing, join B with sc in end of any row of roof, \*sc evenly across ends of rows to next corner, 3 sc in corner, [sc in each st across to center dc of next shell, 3 sc in center st of next shell] 4 times, sc in each st across to corner, 3 sc in corner; repeat from \* once more, sc evenly across ends of remaining rows; join with sl st in first sc. Fasten off.

**Roof Candies**

With yarn needle and double strand of C, work French knots at top of each scallop of snow trim, wrapping yarn around needle twice.

**BUILD CARDBOARD HOUSE**

**Make Paper Patterns**

**Front and Sides** Place crocheted piece on paper. Using ruler to make straight lines, draw around crocheted piece about ¼" (6.5mm) larger on all sides. This will ensure that the crocheted piece will stretch slightly when placed over cardboard house. Cut out pattern piece.

**Half Roof** With ruler, measure distance along front pattern piece from top point down to first corner (the corner formed at Row 13). Measure width of top of side pattern piece. Draw a rectangle using these measurements for the height and length of half roof. Cut out pattern piece.

**Cut Cardboard** Place pattern pieces on cardboard and cut out pieces using box cutter. Cut 2 front pieces (one for front and one for back), 2 side pieces, and 2 half roof pieces.

**Assemble Cardboard** Securely tape front and back pieces to side pieces, forming a rectangular base for house. Then tape roof pieces together at top and to all top edges of base.

**ASSEMBLE CROCHETED HOUSE**

**Note** Hide yarn tails between crocheted pieces and cardboard house.

**Attach Sides and Front/Back Pieces to Base of Cardboard House**

With yarn needle, sew side edges of crocheted sides and first 13 rows of front and back pieces together. Slide sewn piece over cardboard house and glue in place along lower edge. Stretch crocheted piece, as needed, and glue in place along top edges of cardboard base.

**Attach Roof to Cardboard House**

Glue center of crocheted roof along cardboard roof peak, stretching slightly so that while trim extends slightly past crocheted front and back pieces. Stretching slightly, as needed, glue crocheted roof halves in place, one at a time,

so that edges extend slightly over crocheted sides, front, and back pieces.

**ICICLE TRIM (MAKE 2)**

With B, ch 46.

**Row 1** Sl st in 2nd ch from hook, sc in next 2 ch (counts as first long icicle); sl st in next 3 ch, ch 3, sl st in 2nd ch from hook, sc in next ch (short icicle made), sl st in next 3 ch, ch 4, sl st in 2nd ch from hook, sc in next 2 ch (long icicle made), [sl st in next 3 ch, make short icicle] twice, [sl st in next 3 ch, make long icicle, sl st in next 3 ch, make short icicle] 3 times, [sl st in next 3 ch, make short icicle, sl st in next 3 ch, make long icicle] twice—15 icicles. Fasten off. Glue long edge of one icicle trim along roofline of front piece. Glue long edge of other icicle trim along roofline of back piece. Glue each icicle in place pointing straight downward.

**DOOR**

With C, ch 9.

**Row 1** Sc in 2nd ch from hook and in each remaining ch across—8 sc.

**Rows 2–8** Ch 1, turn; sc in each sc across.

**Rows 9–11** Ch 1, turn; sk first sc; sc in each sc to last 2 sc, sc2tog—2 sc.

Fasten off.

**Edging**

With right side facing, join C with sc in lower corner of door, work sc evenly spaced (ensure that piece stays flat) up side, over top, and down opposite side of door. Fasten off.







With E, work French Knot for doorknob. Glue door to center-front of house.

**DOOR WREATH**

With C, ch 7; join with sl st in first ch to form a ring.

**Round 1** Ch 1, work 12 sc in ring; join with sl st in first sc. Fasten off and weave in ends. With a short length of G, tie a tiny bow and glue bow to wreath. Glue wreath to center top of door.

**PEPPERMINT (MAKE 5—2 WITH D AND B, 3 WITH C AND B)**

With B, ch 4; join with sl st in first ch to form a ring.

**Round 1** Ch 1, [sc in ring, ch 1] 5 times; join with sl st in first sc. Fasten off.

**Round 2** Join contrasting color with sc in center of ring, drawing sc out even with outer edge of Round 1, ch 2, [sc in center of ring drawing sc out even with outer edge of Round 1, ch 2] 4 times; join with sl st in first sc. Fasten off and weave in ends.

Glue three C-colored peppermints and two D-colored peppermints to front of house, as shown in photo.

**CANDY ABOVE DOOR**

With G, ch 5; join with sl st in first ch to form a ring.

**Round 1** Ch 1, work 8 sc in ring; join with sl st in first sc. Fasten off. Glue candy, centered, above door.



**WINDOW (MAKE 2)**

**Frame**

With B, ch 28; join with sl st in first ch to form a ring. Fasten off. With straight pins, pin each frame to center of side of house, with 7 chains on each side of frame. Glue in place.

**Pane Frames (Make 2 per Window)**

With B, ch 7. Fasten off. Glue two pane frames to each window in a "+" to form four window panes.

**Shutters (Make 2 per Window)**

With D, ch 9.

**Row 1** Sc in 2nd ch from hook and in each remaining ch across—8 sc.

**Rows 2–4** Ch 1, turn; sc in each sc across. Fasten off.

Glue one shutter on each side of window.

**CORNER CANDY STICKS (MAKE 4)**

With C, ch 25. Fasten off. With D, ch 25. Fasten off. At each end of chains, tie tails together with a square knot. Glue one square knot to lower edge of house corner. Let glue dry completely. Twist chains to form candy stick. Run a line of glue along corner and affix twisted chains. Glue remaining square knot at top of corner. Let glue dry completely. Thread ends onto yarn needle and tack to inside of crochet. Trim ends. Repeat on remaining 3 corners.

**DOOR POSTS (MAKE 2)**

With B, ch 15. Fasten off. With D, ch 15.

Fasten off. Twist and apply chains in same manner as corner candy sticks. Glue one post to each side of door. For best effect, twist door posts in opposite directions.

**DOOR JAMB**

With C, ch 15. Fasten off. With G, ch 15. Fasten off. Twist and apply chains in same manner as corner candy sticks. Glue to lower edge of door.

**CANDY CANES (MAKE 6)**

With B, ch 15. Fasten off. With C, ch 15. Twist and apply chains in same manner as corner candy sticks; curving

*Tip*

*After gluing trims in place, a yarn needle can be used to pull yarn to the inside of the crochet or the ends may be tucked under the end of the trims and glued down securely.*

the top to form a cane. Glue one candy cane to each side of door and each side of each window.

**GUMDROP (MAKE ABOUT 72 IN A MIX OF C, D, E, F, AND G)**

Ch 4, 4 dc in 4th ch from hook; drop loop from hook and insert hook in top of beginning ch-4, pick up dropped loop and draw through, ch 1. Fasten off. Tie yarn tails together to create a rounded shape. Weave yarn tails to inside of gumdrop. Trim tails.

Glue an F-colored gumdrop to the top of each doorpost. Set aside one C-colored gumdrop (for top of tree). Glue gumdrops along roof peak, all around lower edge of house (except along lower edge of door) and along sides of each window.

**TREE**

With D, ch 4; join with sl st in first ch to form a ring.

**Round 1** Ch 1, work 5 sc in ring; do not join—5 sc.

Place marker to indicate beginning of round. Move marker up as work progresses.

**Rounds 2–20** (or to desired height) Working in back loops only, sc in each sc around, working 2 sc in any one st of each round (stagger position of the increase so that increases are not stacked on top of each other)—24 sc.

Sl st in back loop of next st and fasten off and weave in ends.

**Trim**

Join B with sl st in free loop of first st at top of tree. Sl st in free loop of each st to end of Round 20. Fasten off and weave in ends. Glue one C gumdrop to top of tree.

**Note** Tree holds its cone shape well without a bottom piece and without stuffing.



# Retro Ripples Skirt

Trim your tree in retro flair with this snazzy chevron skirt. Sparkly yarn adds a little extra glitter and glam!

By Regina Rioux Gonzalez

## What You'll Need

### YARN

RED HEART Holiday, 3/8oz/100g balls, each approx 235yd/215m (acrylic/metallic polyester)

- 2 balls #9090 Red/Red (A)
- 2 balls #1350 Aran/Gold (B)
- 2 balls #6060 Greens/Green (C)
- 1 ball #6560 Hunter/Gold (D)

### TOOLS & SUPPLIES

- Size K/10½ (10.5mm) crochet hook or any size to obtain correct gauge

### MATERIALS

- Yarn needle

Skill Level: Easy



## ABBREVIATIONS LISTEN TO THIS PROGRAM

ch chain                      sk skip  
 dc double crochet        sp(s) space(s)  
 sc single crochet        st(s) stitch(es)

\* Repeat directions following \* as many times as indicated.

the yarn



Holiday in Hunter/Gold



## FINISHED MEASUREMENTS

Approx 54" (137cm) diameter with 12" (30.5cm) center opening

## GAUGE

12 dc and 7 rows = 4" (10cm)

## HOW TO MAKE A GAUGE SWATCH

Ch 14.

**Row 1** Dc in 4th ch from hook (skipped chs count as dc), dc in each remaining ch across—12 dc.

**Row 2** Ch 3 (counts as dc here and throughout), turn; dc in next st and in each st across, dc in first skipped ch.

**Rows 3–7** Ch 3, turn; dc in next st and in each st across, dc in 3rd ch of turning ch-3. Resulting gauge swatch should measure approx 4" (10cm) square. If necessary, adjust hook size to obtain correct gauge.

## NOTES

1 Work skirt in the following color pattern: 6 rows with A, 2 rows with B, 4 rows with C, 2 rows with A, 6 rows with B, 2 rows with D, 4 rows with A, 5 rows with B.

2 Change color in last st of last consecutive row in specified color as follows: Work last st until 2 loops remain on hook, drop old color, with new color, yarn over and draw through 2 loops on hook. Fasten off old color. Continue with new color.

3 To join with a sc, make a slip knot and place on hook. Work sc in indicated st.

## TREE SKIRT

With A, ch 153.









**Row 1** (right side) Dc in 4th ch from hook (skipped chs count as dc), dc in next 3 chs, \*sk next 2 chs, dc in next 4 chs, ch 2, dc in next 4 chs; repeat from \* across to last 6 chs, sk next 2 chs, dc in next 3 chs, 2 dc in last ch—122 dc and 14 ch-2 sps.

**Row 2** Ch 3 (counts as dc here and throughout), turn; dc in first 4 sts, \*sk next 2 sts, dc in next 3 sts, (dc, ch 2, dc) in next ch-2 sp, dc in next 3 sts; repeat from \* across to last 6 sts, sk next 2 sts, dc in next 3 sts, 2 dc in first skipped ch.

**Row 3** Ch 3, turn; dc in first st, 2 dc in next st, dc in next 2 sts, \*sk next 2 sts, dc in next 2 sts, 2 dc in next st, (dc, ch 2, dc) in next ch-2 sp, 2 dc in next st, dc in next 2

sts; repeat from \* across to last 6 sts, sk next 2 sts, dc in next 2 sts, 2 dc in next st, 2 dc in 3rd ch of turning ch-3—152 dc and 14 ch-2 sps.

**Row 4** Ch 3, turn; dc in first 5 sts, \*sk next 2 sts, dc in next 4 sts, (dc, ch 2, dc) in next ch-2 sp, dc in next 4 sts; repeat from \* across to last 7 sts, sk next 2 sts, dc in next 4 sts, 2 dc in 3rd ch of turning ch-3.

**Rows 5–30** Repeat Rows 3 and 4, 13 more times, increasing underlined numbers by one more st in each repeat—30 more dc in each of the 2 rows than in each of the previous 2 rows—182 dc and 14 ch-2 sps at end of Rows 5 and 6—542 dc and 14 ch-2 sps at end of Rows 29 and 30.

**Row 31** Ch 1, turn; sc in each st across and 2 sc in each ch-2 sp—570 sc. Fasten off.

**Edging**

With right side facing, join B with sc in beginning edge of Row 1, sc evenly spaced along edges of rows, ending with sc in edge of Row 31. Fasten off. With right side facing, join B with sc in ending edge of Row 31, sc evenly spaced along edges of rows, ending with sc in edge of Row 1. Fasten off.

**Finishing**

Weave in ends.

STITCH DIAGRAM

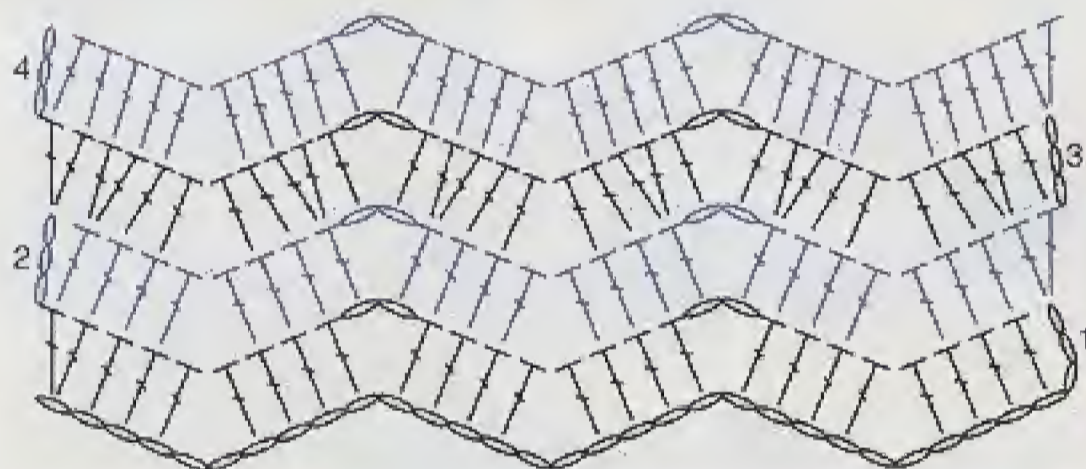

*Tip*

To make a smaller tree skirt, work fewer foundation chains in repeats of 10 and work fewer rows.









# Candy Shop Ornaments

Old-fashioned candies inspired these sweet ornaments—stitch up a whole batch and add the perfect vintage touch to your tree.

By Susan Jeffers

## What You'll Need

**Yarn**  
AUNT LYDIA'S Fashion Crochet Thread, Size 3, each ball approx 150yd/137m (color)  
1 ball each:

- #201 White (A)
- #16 Scarlett (B)
- #175 Warm Blue (C)
- #166 Navy (D)
- #65 Warm Teal (E)

### HOOKS

- Size F/5 (3.75mm) crochet hook
- Size 0 (3.25mm) steel crochet hook or any size to obtain correct gauge

### NOTIONS

- Stitch markers
- Polyester fiberfill
- 3 pieces of 1½" x 7.5cm wide white satin ribbon, each 10" x 25.5cm long
- 3 white chenille stems, each approx 3" x 7.5cm long
- Invisible thread
- Yarn needle

Skill Level: Easy



## the yarn

Fashion Crochet Thread  
Size 3 in Scarlett



## ABBREVIATIONS USED IN THIS PATTERN

ch(s) chain(s)      sk skip  
sc single crochet    st(s) stitch(es)

\* Repeat directions following \* as many times as indicated.

[ ] Work directions inside brackets as many times as indicated.

## SPECIAL ABBREVIATIONS

**inv-dec** (invisible decrease) Insert hook in front loop of next st; **DO NOT YARN OVER**, insert hook in front loop of next st, yarn over and draw through 2 front loops, yarn over and draw through 2 loops on hook.

**Note** Work inv-dec in back loops instead of front loops on Round 9 of Peppermint Candy.

## SPECIAL TECHNIQUE

**adjustable ring method** Holding the thread a few inches from the end, wrap around your finger. Do not remove wrap from finger, insert hook into the wrap and draw up a loop of working thread. Chain one to secure the loop, and remove ring from finger. Work stitches of first round in the ring. Pull gently, but firmly, on tail to tighten ring.

## FINISHED MEASUREMENTS

**peppermint candy** Approx 2¾" x 7cm diameter x 1½" x 4cm thick

**candy cane** Approx 6" x 15cm high x 2" x 5cm wide x ¾" x 2cm diameter when stuffed and bent into final shape

**ribbon candy** Approx 1½" x 4cm wide x 3¾" x 8.5cm long

## GAUGE

Gauge is not important for Candy Cane and Peppermint Candy ornaments. Work tightly to prevent holes in your work.

**ribbon candy** 5 sc = 1" x 2.5cm; 7 rows = 1½" x 4cm

## NOTES

- 1 Use size F crochet hook to make Peppermint Candy and Candy Cane ornaments and size 0 crochet hook to make Ribbon Candy ornament.
- 2 All three ornaments are made holding two strands together throughout.
- 3 Peppermint Candy and Candy Cane ornaments are worked in a continuous spiral.
- 4 To change colors, work last stitch of old color until 2 loops remain on hook, drop old color, yarn over with new color and draw through 2 loops on hook. Continue with new color until next color change.
- 5 Stuff first 24 rounds of Candy Cane ornament as you work, rolling candy cane between your hands to smooth and round it.
- 6 Ribbon candy ornament should measure approx 18" x 45.5cm long before finishing.

## Tip

Make some spearmint candies with white and green thread to coordinate with peppermint candies.







**PEPPERMINT CANDY ORNAMENT**

With size F hook and 2 strands of A held together, form an adjustable ring.

**Round 1** Work 8 sc in ring—8 sc.

**Round 2** Work 2 sc in each st around—16 sc.

**Round 3** Work [2 sc in next st, sc in next st] 8 times—24 sc.

**Round 4** Work [2 sc in next st, sc in next 2 sts] 8 times—32 sc.

**Round 5** [With A, 2 sc in next st, sc in next st, changing to B; with B, sc in next 2 sts, changing to A in last st] 8 times—40 sc.

**Round 6** [With A, sc in next 3 sts, changing to B in last st; with B, sc in next 2 sts, changing to A in last st] 8 times.

**Round 7** Working in back loops, repeat Round 6.

**Round 8** Repeat Round 6.

**Round 9** Working in back loops, (with A, work inv-dec in back loops, sc in next st, changing to B; with B, sc in next 2 sts, changing to A in last st) 8 times—32 sc. Fasten off B.

**Round 10** [With A, work inv-dec, sc in next 2 sts] 8 times—24 sc.

**Round 11** [Work inv-dec, sc in next st] 8 times—16 sc. Stuff firmly.

**Round 12** [Work inv-dec] 8 times—8 sc. Fasten off, leaving a long tail.

**Finishing**

Weave tail in and out through back loop of each stitch on last round. Pull tight to close opening. Weave in ends. Flatten slightly to shape candy. Insert ribbon around any stitch on Round 7 and tie ends in a knot to hang ornament.

**CANDY CANE ORNAMENT**

With size F hook and 2 strands of A held together, ch 2.

**Round 1** Work 8 sc in 2nd ch from hook—8 sc.

**Round 2** With A, sc in next 5 sts, changing to B in last st; with B, sc in next 3 sts, changing to A in last st.

**Round 3** With A, sc in next 6 sts, changing to B in last st; with B, sc in next 2 sts.

**Round 4** With B, sc in next st, changing to A; with A, sc in next 6 sts, changing to B in last st; with B, sc in next st.

**Round 5** With B, sc in next 2 sts, changing to A in last st; with A, sc in next 6 sts, changing to B in last st.

**Round 6** With B, sc in next 3 sts, changing to A in last st; with A, sc in next 5 sts.

**Round 7** With A, sc in next st, changing to B; with B, sc in next 3 sts, changing to A in last st; with A, sc in next 4 sts.

**Round 8** With A, sc in next 2 sts, changing to B in last st; with B, sc in next 3 sts, changing to A in last st; with A, sc in next 3 sts.

**Round 9** With A, sc in next 3 sts, changing to B in last st; with B, sc in next 3 sts, changing to A in last st; with A, sc in next 2 sts.

**Round 10** With A, sc in next 4 sts, changing to B in last st; with B, sc in next 3 sts, changing to A in last st; with A, sc in next st.

**Rounds 11–34** Repeat Rows 2–10, 2 more times, then repeat Rows 2–7 once more. Fasten off B and stuff tails inside cane.

**Round 35** With A, sc in next 8 sts. Fasten off A, leaving a long tail.

**Finishing**

Twist 2 chenille stems together. Take 3rd chenille stem and twist it around other 2 stems. Insert twisted stems down center of candy cane and cut off excess stems  $\frac{1}{2}$ "/1.5cm below top of cane. Stuff a small amount of fiberfill over ends of stems. With tapestry needle, weave tails of A through last round, closing end of cane. Weave in ends. Bend upper  $1\frac{1}{2}$ "/4cm of candy cane down and shape as desired. Insert ribbon under center stitch at top of candy cane and tie ends in a knot to hang ornament.

**RIBBON CANDY ORNAMENT**

With size 0 hook and 2 strands of C held together, ch 91.

**Row 1** (right side) Sc in back bar of 2nd ch from hook and in back bar of each remaining ch across—90 sc. Fasten off.

**Row 2** With right side facing, join D with sc in first sc, sc in each sc across. Fasten off.

**Rows 3–7** Repeat Row 2, 5 more times, using C for Rows 3, 5, and 7; E for Row 4; and D for Row 6. Fasten off.

**Finishing**

Weave in ends. Starting at beginning of piece, place 16 markers in both long edges of piece in the following stitch numbers: 1, 11, 14, 21, 25, 32, 36, 43, 47, 54, 58, 65, 69, 77, 80, and 90. Fold beginning short edges over and tack 1st and 3rd marked stitches together on one long edge with







invisible thread. Fold in opposite direction and tack 2nd and 4th marked stitches together. Continue folding piece in opposite directions, tacking 5th and 7th, 6th and 8th, 9th and 11th, 10th and 12th, 13th and 15th, 14th and 16th marked stitches together. Tack short edge across to other long edge. Tack marked stitches together along other long edge in same manner. Tack down other short edge. Remove markers. Insert ribbon around center stitch on either short edge and tie ends in a knot to hang ornament.

PEPPERMINT-CANDY STITCH DIAGRAM

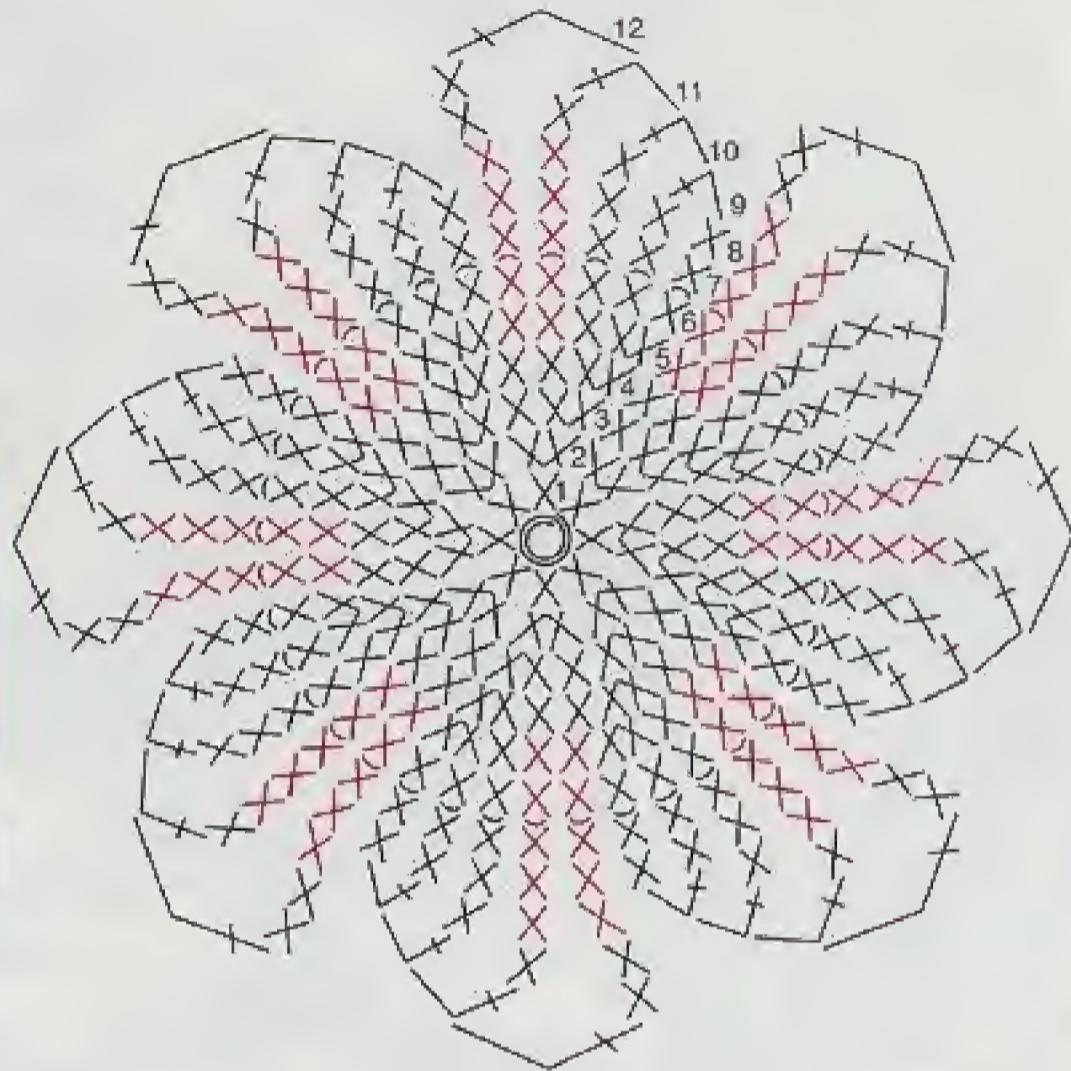

Tip

When thread gets twisted, simply twist Candy Cane in opposite direction to untwist threads.

CANDY CANE STITCH DIAGRAM

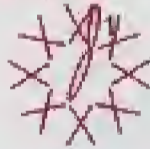
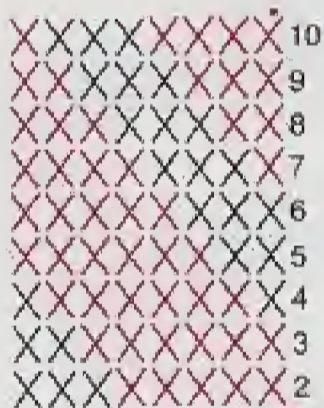

Note

Rounds 2 and up build upon round 1 as established, work every round in a continuous spiral.

RIBBON CANDY STITCH DIAGRAM









# Sparkly Snowflakes

Add a little luster to dark winter nights with this cozy afghan, stitched in shimmering yarn. Join-as-you-go construction makes it surprisingly quick to finish!

By Kim Kotary

## What You'll Need

### YARN

RED HEART Holiday, 3½oz/100g balls, each approx 236yds/215m (acrylic/metallic polyester)

- 3 balls #140 White/Silver (A)
- RED HEART Super Saver, 7oz/198g skeins, each approx 364yds/333m (acrylic)

- 3 skeins #380 Windsor Blue (B)

### CROCHET HOOK

- Size I/9 (5.5mm) crochet hook or any size to obtain correct gauge

### NOTIONS

- Yarn needle

Skill Level: Easy



## the yarn



Super Saver in Windsor Blue



Holiday in White/Silver

## FINISHED MEASUREMENTS

Approx 54"/137cm x 47"/119.5cm at widest point

## GAUGE

Rounds 1–6 on motif = 9"/23cm diameter (between 2 opposite straight sides)

*Remember to check gauge for best results!*

## THROW

### Motif (Make 33)

With A, ch 6; join with sl st to form a ring.

**Round 1** (right side) Work beginning cl in rkg, ch 2, [cl in ring, ch 2] 5 times; join with sl st in top of beginning cl—6 cl and 6 ch-2 sps.

**Round 2** (Sl st, beginning cl, ch 2, cl) in next ch-2 sp, ch 2, \*(cl, ch 2, cl) in next ch-2 sp, ch 2; repeat from \* around; join with sl st in top of beginning cl—12 cl and 12 ch-2 sps.

**Round 3** (Sl st, beginning cl, ch 3, cl) in next ch-2 sp, \*ch 3, sl st in next ch-2 sp, ch 3\*\*, (cl, ch 3, cl) in next ch-2 sp; repeat from \* around, ending last repeat at \*\*; join with sl st in top of beginning cl—12 cl, 6 sc and 18 ch-3 sps.

**Round 4** (Sl st, beginning cl, ch 1, cl, picot, ch 1, cl) in next ch-3 sp, \*(ch 3, sc in next ch-3 sp) 2 times, ch 3\*\*, (cl, ch 1, cl, picot, ch 1, cl) in next ch-3 sp; repeat from \* around, ending last repeat at \*\*; join with sl st in top of beginning cl—18 cl, 12 sc, 6 picots, 18 ch-3 sps and 12 ch-1 sps. Fasten off.

**Round 5** With right side facing, join B with sl st in any ch-1-sp after a picot, 2 sc in same ch-1 sp, \*2 dc in next ch-3 sp, dc in next ch-3 sp; working over sl st in Round 3, tr in next ch-2 sp on Round 2, dc in same ch-3 sp as last dc made, 2 dc in next ch-3 sp, 2 sc in

## ABBREVIATIONS USED IN THIS PATTERN

ch(s) chain(s)      sl st slip stitch  
dc double crochet      sp(s) space(s)  
sc single crochet      st(s) stitch(es)  
sk skip      tr treble crochet

\* Repeat directions following \* as many times as indicated.

[ ] Work directions inside brackets as many times as indicated.

( ) Work directions inside parentheses into st or sp indicated.

## SPECIAL ABBREVIATIONS

cl (cluster) [Yarn over, insert hook in next st, yarn over and draw up a loop, yarn over and draw through 2 loops on hook] twice, yarn over and draw through all 3 loops on hook.

beginning cl (beginning cluster) Ch 2, dc in indicated st or sp.

picot Ch 4, sl st in top of last sc made.

picot join Ch 2, sl st in corresponding picot on adjacent motif, ch 2, sl st in top of last sc made on current motif.

next ch-1-sp, ch 1 behind next picot\*\*, 2 sc in next ch-1 sp; repeat from \* around, ending last repeat at \*\*; join with sl st in first sc—6 tr, 36 dc and 24 sc.

**Round 6** Ch 3 (counts as dc), \*sk next 2 sc, 2 dc in sp before next 2 dc, sk next 2 dc, 2 dc in sp before next 3 sts, sk next 3 sts, 2 dc in sp before next 2 dc, sk next 2 dc, 2 dc in sp before next 2 sc, sk next 2 sc\*\*; working behind next picot, (2 dc, ch 3, 2 dc) in next ch-1-sp; repeat from \* around, ending last repeat at \*\*; working behind last picot, (2 dc, ch 3, dc) in last ch-1 sp; join with sl st in 3rd ch of beginning ch-3—72 dc and 6 corner ch-3 sps.

### Motif 1

**Round 7** Ch 1, sc in same ch as joining, picot, \*sc in next 2 dc, picot; repeat from \* around, working (2 sc, picot) in each corner ch-3 sp, sc in last dc; join with sl st in first sc—84 sc and 42 picots. Fasten off.

### Motifs 2–33

Join motifs into 6 rows with one-side, two-side, or three-side joining while working Round 7 following assembly diagram as follows:

**Round 7 (One-Side Joining)** Ch 1, sc in same ch as joining, picot, \*sc in next 2 dc, picot; repeat from \* across to next corner\*\*;



(2 sc, picot) in next corner ch-3 sp; repeat from \* 4 more times, ending last repeat at \*\*, 2 sc in next corner ch-3 sp, picot join, [sc in next 2 dc, picot join] 6 times, 2 sc in last corner ch-3 sp, picot, sc in last dc; join with sl st in first sc—84 sc, 35 picots, and 7 picot joins. Fasten off.

**Round 7 (Two-Side Joining)** Ch 1, sc in same ch as joining, picot, \*sc in next 2 dc, picot; repeat from \* across to next corner\*\*, (2 sc, picot) in next corner ch-3 sp; repeat from \* 3 more times, ending last repeat at \*\*, \*\*\*2 sc in next corner ch-3 sp, picot join, [sc in next 2 dc, picot join] 6 times; repeat from \*\*\* once more on next adjacent motif, 2 sc in last corner ch-3 sp, picot, sc in last dc; join with sl st in

first sc—84 sc, 28 picots, and 14 picot joins. Fasten off.

**Round 7 (Three-Side Joining)** Ch 1, sc in same ch as joining, picot, \*sc in next 2 dc, picot; repeat from \* across to next corner\*\*, (2 sc, picot) in next corner ch-3 sp; repeat from \* 2 more times, ending last repeat at \*\*, \*\*\*2 sc in next corner ch-3 sp, picot join, [sc in next 2 dc, picot join] 6 times; repeat from \*\*\* 2 more times on next 2 adjacent motifs, 2 sc in last corner ch-3 sp, picot, sc in last dc; join with sl st in first sc—84 sc, 21 picots, and 21 picot joins. Fasten off.

**FINISHING**

Weave in all ends.

**ASSEMBLY DIAGRAM**

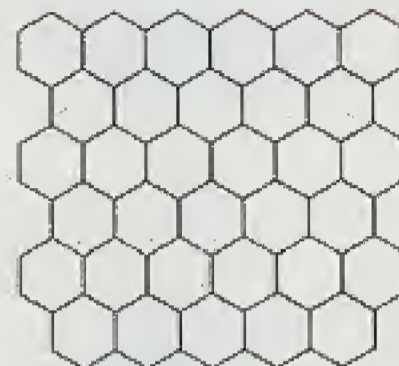

**STITCH DIAGRAM**

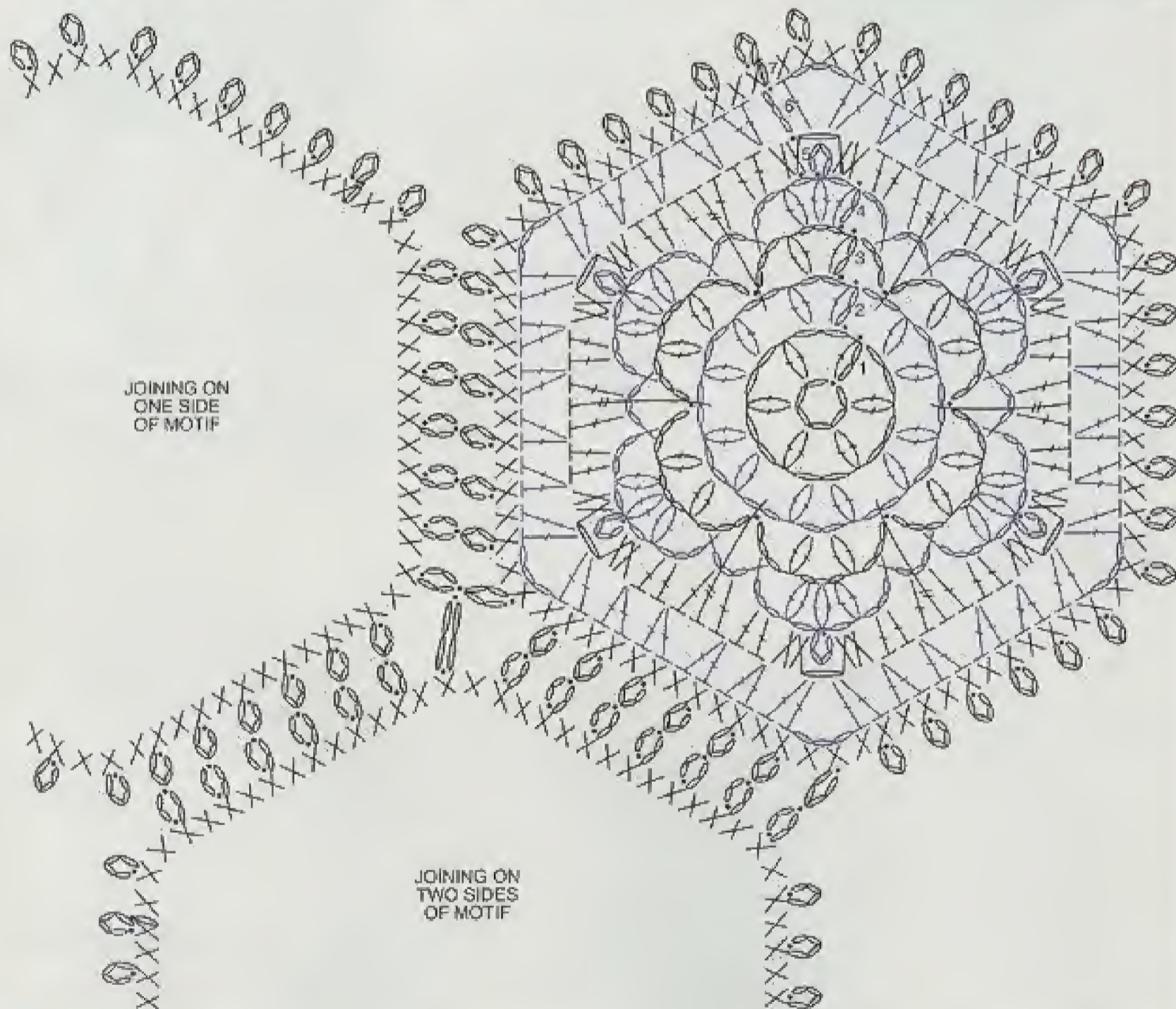



# Stuffable Stockings

Add some retro flair to your mantel with these punchy granny stockings. Hexagon motifs are easy to stitch in any color combo for a fun, festive look!

By Lauren Osborne



crochet today! 37



## What You'll Need

### YARN

RED HEART Soft Yarn, 5oz/140g balls, each approx 256yd/234m (acrylic) 3 balls each:

- #9523 Dark Leaf (A)
- #5142 Cherry Red (B)
- #4601 Off White (C)
- #9522 Leaf (D)

**Note** One ball of each color is sufficient for making any one of the stockings.

### CROCHET HOOK

- Size G/6 (4mm) crochet hook or any size to obtain correct gauge

### NOTIONS

- Yarn needle

Skill Level: Easy

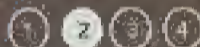

### ABBREVIATIONS USED IN THIS PATTERN

ch chain	sl st slip stitch
dc double crochet	sp space(s)
sc single crochet	st(s) stitch(es)
sk skip	tr treble crochet

\* Repeat directions following \* as many times as indicated.

[ ] Work directions in brackets number of times indicated.

( ) Work directions in parentheses into stitch or space indicated

### FINISHED MEASUREMENTS

Approx 21<sup>1</sup>/<sub>2</sub>/53.5cm long (measured from top of cuff straight down to tip of toe) and 12<sup>1</sup>/<sub>2</sub>/30.5cm from back of heel straight across to tip of toe

### GAUGE

1 hexagon = 4 x 4<sup>1</sup>/<sub>2</sub>"/10 x 11.5cm  
Gauge is not critical for this project.

### NOTES

1 Gauge is not critical for this project. However, work tightly enough to ensure that small objects won't fall through.

2 To reduce the amount of finishing work, crochet over ends as you go.

3 Hexagons are worked with right side facing throughout. Do not turn at end of rounds.

4 You may change colors at the end of each round in any order you desire. The models shown were made using the following color sequences:

Color sequence #1: Work Rounds 1–3 with C, Round 4 with D. Join hexagons with B.

Color sequence #2: Work Round 1 with C, Round 2 with D, Round 3 with A, and Round 4 with B. Join hexagons with C.

Color sequence #3: Work Rounds 1 and 2 with B, rounds 3 and 4 with A. Join hexagons with D.

5 To change color at the end of a round (in join): Insert hook in indicated st, yarn over with new color and draw through all loops on hook to complete join. Work next round with new color, working over old color. Fasten off old color and weave in tail.

6 When assembling the foot of the stocking, it is easiest if you add the hexagon at the top of the toe last.

### HEXAGON (MAKE 17)

Ch 6; join with sl st in first ch to form a ring.

**Round 1** (right side) Ch 3 (counts as dc here and throughout), work 11 more dc in ring; join with sl st in top of beginning ch—12 dc.

**Round 2** Ch 3, dc in same st as join, 2 dc in each st around; join with sl st in top of beginning ch—24 dc.

**Round 3** Ch 3, 2 dc in same st as join, sk next st, [3 dc in next st, sk next st] 11 times; join with sl st in top of beginning ch—36 dc (consisting of twelve 3-dc groups).

**Round 4** Ch 3, dc next 4 dc, (tr, ch 1, tr) in next dc (corner made), \*dc in next 5 dc, (tr, ch 1, tr) in next dc; repeat from \* around; join with sl st in top of beginning ch—6-(tr, ch 1, tr) corners, and 30 dc (consisting of 5 dc along each of 6 sides). Fasten off and weave in ends.

### STITCH DIAGRAM

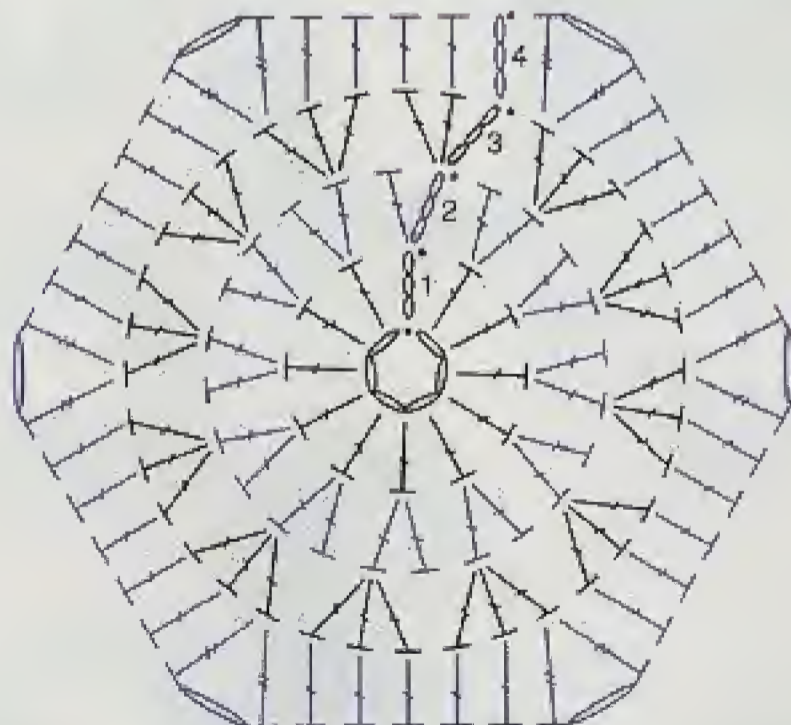

the yarn



Soft Yarn in Leaf



## Tip

The hexagons can be joined in many different orders. The assembly diagram provides one suggested order for joining. You may wish to join the hexagons in another order.





**ASSEMBLY**

Refer to assembly diagram frequently while assembling stocking. Determine placement of hexagons and join hexagons, one edge at a time, beginning at a corner ch-1 sp, working across the edge, and ending in the next corner ch-1 sp.

**Joining One Edge of Two Hexagons** Hold two hexagons with wrong sides together. Join yarn with sc in the first ch-1 sp of both hexagons; working through both thicknesses, sc in each st across edge, sc in last ch-1 sp.

**Note** To reduce the number of ends to weave in, do not fasten off. Instead, join the next hexagon (refer to assembly diagram) along the next edge of one of the current hexagons.

**FINISHING**

**Top Edging** With right side facing, join yarn with sc in back of top edge; sc evenly around the top of the stocking, ch 12 (for hanging loop) and join with sl st in first sc. Weave in all ends. Block lightly if desired.



**ASSEMBLY DIAGRAM**

**Step #1:** Join 16 hexagons arranged as shown.

**Step #2:** Fold piece along vertical dashed lines and join edges A, B, C, D, and E.

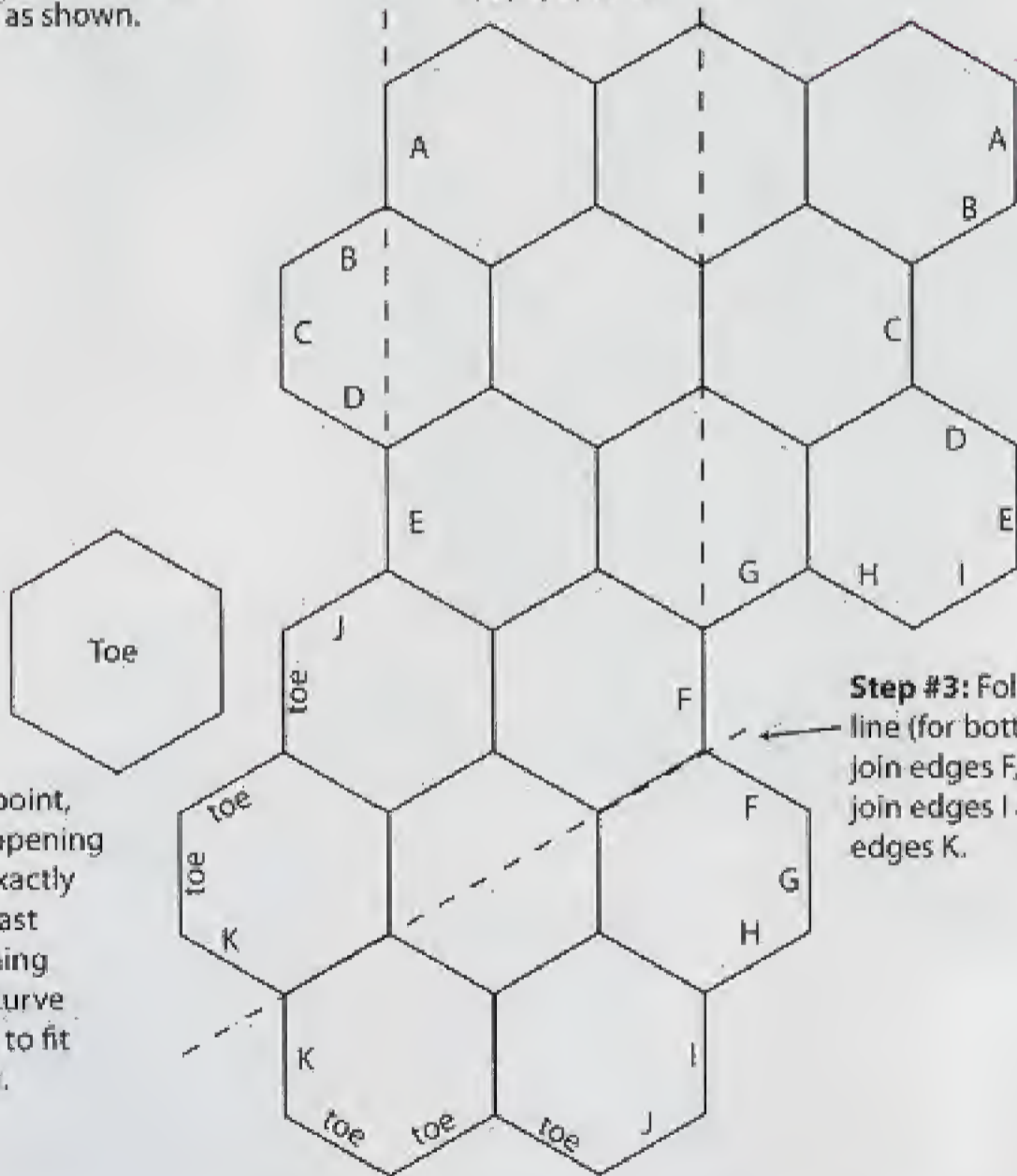

**Step #3:** Fold along dashed line (for bottom of foot) and join edges F, G, and H, then join edges I and J, and finally edges K.

**Step #4:** At this point, there will be an opening at the toe with exactly six edges. Place last hexagon in opening at toe and join. Curve the toe hexagon to fit into the opening.



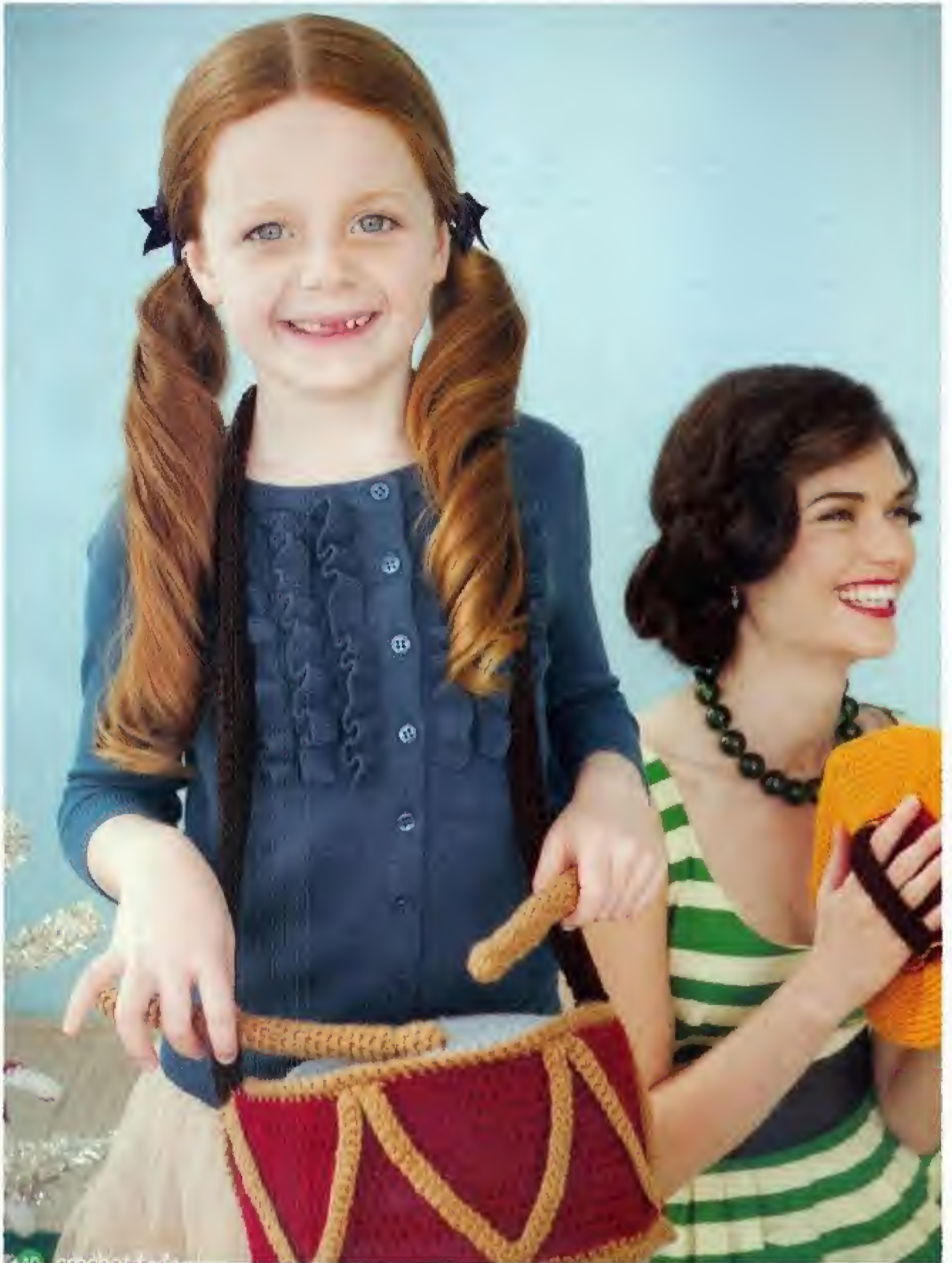



# Little Drummer Set

 the yarn

Super Saver in Ranch Red

Who wouldn't love to find this pretend drum and cymbals under the tree? Make several sets, and your little ones can form their own make-believe marching troop!

By Sally Byrne



## What You'll Need

### YARN

RED HEART Super Saver, 7oz/198g skeins, each approx 364yd/333m (acrylic)  
1 skein each:

- #336 Warm Brown (A)
- #332 Ranch Red (B)
- #883 Spa Blue (C)
- #321 Gold (D)
- #365 Coffee (E)

### CROCHET HOOK

- Size G/7 (4.5mm) crochet hook or any size to obtain correct gauge

### NOTIONS

- 25½ x 4¼/65 x 11.5cm piece of lightweight cardboard (a cereal box works well)
- Tape
- Stitch markers
- Polyester fiberfill
- Yarn needle

Skill Level: Easy

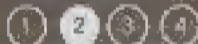

## ABBREVIATIONS USED IN THIS PATTERN

ch chain                    sc single crochet  
dc double crochet    sl st slip stitch  
hdc half double crochet    st(s) stitch(es)

[ ] Work directions in brackets number of times indicated.

### SPECIAL ABBREVIATION

**inv-dec** (invisible decrease) Insert hook in front loop only of next 2 stitches, yarn over and draw through all loops on hook.

## FINISHED MEASUREMENTS

**drum** Approx 9"/23cm diameter and 5"/12.5cm high  
**drumsticks** Approx 8"/20.5cm long  
**cymbals** Approx 9½"/24cm diameter

## GAUGE

Rounds 1–9 of top of drum = 4"/10cm diameter

*Gauge is not critical for this project.*

## HOW TO MAKE A GAUGE SWATCH

Work Rounds 1–9 of top of drum. Resulting gauge swatch should measure approx 4"/10cm diameter. *If necessary, adjust hook size to obtain correct gauge.*

## NOTES

**1** Some parts of this project are worked in continuous rounds. Do not join and do not turn after completing a round, unless otherwise instructed.

**2** To change color, work last stitch of old color to last yarn over; yarn over with new color and draw through all loops on hook to complete stitch. Continue to work with new color. Fasten off old color.

## DRUM

### Top

With C, ch 2.

**Round 1** Work 6 sc in 2nd ch from hook; do not join—6 sc.

Place a marker to indicate the beginning of the round and move the marker up as each round is completed.

**Round 2** 2 sc in each sc around—12 sc.

**Round 3** [Sc in next sc, 2 sc in next sc] 6 times—18 sc.

**Round 4** [Sc in next 2 sc, 2 sc in next sc] 6 times—24 sc.

**Round 5** [Sc in next 3 sc, 2 sc in next sc] 6 times—30 sc.

**Round 6** [Sc in next 4 sc, 2 sc in next sc, place a marker in last sc made] 6 times—36 sc.

**Note** The markers placed in Round 6 indicate the six increase locations. Move these markers up as work progresses. When you work 2 sc into a marked sc, move the marker into the last of the 2 sc just made.

**Rounds 7–16** [Sc in each sc to next marked increase location, 2 sc in marked sc] 6 times; change to A in last sc of Round 16—96 sc.

Remove increase markers. Do not remove beginning of round marker.

**Round 17** With A, working in back loops only, sc in each sc around; change to B in last sc.

### Sides

**Round 18** With B, working in back loops only, sc in each sc around.

**Rounds 19–30** Hdc in each sc around; change to A in last hdc.

**Round 31** With A, working in back loops only, sc in each st around. Sl st in next st and fasten off.

### Finishing

**Top Edge** With right side facing, join A with sc in free front loop of any sc of Round 17 (the A colored round between top and sides), sc in each free loop around; join with sl st in first sc. Fasten off.



**Prepare Drum** Tape the short ends of the 25½ x 4½/16.5 x 11.5cm piece of cardboard together to form a wide tube, and insert into the drum. Trim cardboard, if needed, to fit. Stuff tube with fiberfill.

**Bottom**

Work as for top of drum through Round 16—96 sts. Sl st in next st and fasten off.

**Round 17** With right side facing, place bottom in opening of drum. Working through both thicknesses (last round of bottom and last round of sides), join A with sc in any st, sc in each st around; join with sl st in first sc. Fasten off.

**Zigzag Stripes (Make 6)**

With A, ch 40.

**Row 1** Sc in 2nd ch from hook and in each remaining ch across—39 sc. Fasten off. Place six stitch markers evenly spaced around the top edge of the drum, placing a marker in every 16th stitch and leaving 15 “holes” between markers.

With A, sew each end of one stripe to two neighboring markers along top edge of drum. Sew the center of the stripe to the bottom edge of the drum, centered between ends at the top edge. Repeat this process around to sew the remaining five stripes to the drum.

**Strap**

With E, ch 150 (or desired length).

**Row 1** Sc in 2nd ch from hook and in each remaining ch across—149 sc.

**Rows 2 and 3** Ch 1, turn; sc in each sc across.

**Row 4** Ch 1, turn; working in back loops only, sc in each sc across.

**Row 5** Ch 1, turn; sc in each sc across. Fasten off, leaving a 60”/152.5cm tail.

**Finishing**

Fold strap in half lengthwise, along Row 4. Thread long tail onto yarn needle and sew the long edges together. Sew ends of strap to opposite sides of top of drum.

**DRUMSTICK (MAKE 2)**

With A, ch 2.

**Round 1** Work 6 sc in 2nd ch from hook; do not join—6 sc.

**Round 2** Sc in each sc around.

Repeat Round 2 until piece measures 6”/20.5cm from beginning, stuffing with fiberfill as you go. Fasten off, leaving a 5”/12.5cm tail.

**Finishing**

Thread tail through stitches of last round and pull tight to gather. Weave in end. Cut a 4”/10cm strand of A. Wrap the strand of A around one end of the drumstick, approx 1”/2.5cm from the end, and knot. Weave in the ends.

**CYMBAL (MAKE 2)**

With D, ch 2.

With D, work as for top of drum through Round 6—36 sc.

**Rounds 7–19** With D, repeat Round 7 of top of drum 13 times—114 sc.

Remove increase markers. Do not remove beginning of round marker.

**Round 20** Working in back loops only, sc in each sc around.

**Round 21** [Sc in next 17 sc, inv-dec] 6 times—108 sc.

**Round 22** [Sc in next 16 sc, inv-dec] 6

times—102 sc.

**Round 23** [Sc in next 15 sc, inv-dec, place a marker in the decrease just made] 6 times—96 sc.

**Note** The markers placed in Round 23 indicate the six decrease locations. Move these markers up as work progresses.

**Rounds 24–30** [Sc in each sc to 1 sc before marked decrease location, inv-dec] 6 times—54 sc.

Sl st in next st and fasten off.

**Handle Base**

With B, work as for top of drum through Round 10—60 sts. Sl st in next st and fasten off.

**Handle Strap**

With E, ch 18

With E, work as for drum strap through Row 5—17 sc. Fasten off, leaving a 12”/30.5cm tail.

**Finishing**

Fold handle strap in half lengthwise, along Row 4. Thread long tail onto yarn needle and sew the long edges together. Sew ends of strap to opposite side edges of handle base. With D, sew handle into center opening of cymbal, sewing through all thicknesses. Weave in all ends.



**Tip**  
Use different color stitch markers for marking the increase or decrease locations and marking the beginning of a round.



# Winter Whites

**A** few simple patterns will give you a wardrobe of winter whites with a modern twist. From cozy sweaters to elegant coats, you'll find everything you need to keep you warm.

The new classic P52

[www.crochettoday.com](http://www.crochettoday.com)

crochet today! 43



# Icicles Pullover

Challenge your skills with this striking sweater—a diagonal stitch pattern adds visual interest and flattering lines.

By Elena Malo

## What You'll Need

### YARN

RED HEART Eco-Ways Bamboo Wool, 134oz/50g skeins, each approx 87yd/80m (bamboo/wool)

- 12 (15, 17, 20) skeins #3116 Ivory

### CROCHET HOOK

- Size J/10 (6mm) crochet hook or any size to obtain correct gauge

### TOOLS

- Yarn needle

Skill Level: Experienced

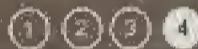

the yarn



Eco-Ways Bamboo Wool in Ivory



## ABBREVIATIONS USED IN THE PATTERN

ch chain                      st/st slip stitch  
sc single crochet          sp(s) space(s)  
sk skip                        st(s) stitch(es)

[ ] Work directions in brackets number of times indicated.

\* Repeat directions following \* as many times as indicated.

### TECHNIQUE ABBREVIATIONS

**BPdc** (Back Post double crochet) Yarn over, insert hook from back to front to back again around post of indicated stitch, yarn over and draw up a loop, [yarn over and draw through 2 loops on hook] twice.

**FPdc** (Front Post double crochet) Yarn over, insert hook from front to back to front again around post of indicated stitch, yarn over and draw up a loop, [yarn over and draw through 2 loops on hook] twice.

**dc2tog** (double crochet 2 stitches together) [Yarn over, insert hook in next st, yarn over and draw up a loop, yarn over and draw through 2 loops on hook] twice, yarn over and draw through all 3 loops on hook.

## DIAGONAL LACE PATTERN (MULTIPLE OF 10 STS + 7)

**Note** The double asterisks (\*\*) is used as a reference point when working the pieces. Refer back to these spots as directed.

**Row 1** (wrong side) Ch 2 (counts as first dc here and throughout), turn; \*\*BPdc around next 4 dc, ch 1, sk next dc, \*sc in next ch-1 sp, ch 4, sc in next ch-4 sp, ch 1, dc in next ch-1 sp, BPdc around next 4 dc, ch 1, sk next dc; repeat from \* across, dc in last dc (top of turning ch).

**Row 2** Ch 2, turn; \*\*sc in next ch-1 sp, ch 1, sk next dc, \*FPdc around next 4 dc, dc in next ch-1 sp, ch 1, sc in next ch-4 sp, ch 4, sc in next ch-1 sp, ch 1, sk next dc; repeat from \* to last 4 dc, FPdc around next 3 dc, dc in last dc.

**Row 3** Ch 2, turn; \*\*BPdc around next 2 dc, ch 1, sk next dc, sc in next ch-1 sp, \*ch 4, sc in next ch-4 sp; ch 1, dc in next ch-1 sp, BPdc around next 4 dc, ch 1, sk next dc, sc in next ch-1 sp; repeat from \* across, ch 3, dc last dc.

**Row 4** Ch 2, turn; \*\*sc in first ch-sp, ch 4, sc in next ch-1 sp, ch 1, sk next dc, \*FPdc around next 4 dc, dc in next ch-1 sp, ch 1, sc in next ch-4 sp, ch 4, sc in next ch-1 sp, ch 1, sk next dc; repeat from \* across to last 2 dc, FPdc around next dc; dc in last dc.

**Row 5** Ch 3 (counts as dc, ch 1 here and throughout), turn; \*\*sc in first ch-1 sp, ch 4, sc in next ch-4 sp, ch 1, \*dc in next ch-1 sp, BPdc around next 4 dc, ch 1, sk next dc, sc in next ch-1 sp, ch 4, sc in next ch-4 sp; ch 1; repeat from \* across, dc in last dc.

**Row 6** Ch 2, turn; \*\*dc in first ch-1 sp, ch 1, sc in next ch-4 sp, ch 4, \*sc in next ch-1 sp, ch 1, sk next dc, FPdc around next 4 dc, dc in next ch-1 sp; ch 1, sc in next ch-4 sp, ch 4; repeat from \* across to last ch-sp, sc in last ch-sp, dc in 2nd ch of turning ch.

**Row 7** Ch 5 (counts as dc, ch 3 here and throughout), turn; sc in first ch-4 sp, ch 1, dc in next ch-1 sp, \*BPdc around next 4 dc, ch 1, sk next dc, sc in next ch-1 sp, ch 4, sc in next ch-4 sp, ch 1, dc in next ch-1 sp; repeat from \* across to last 2 dc, BPdc around next dc, dc in last dc.

**Row 8** Ch 2, turn; \*\*FPdc around next 2 dc, dc in next ch-1 sp, ch 1, \*sc in next ch-4 sp, ch 4, sc in next ch-1 sp, ch 1, sk next dc, FPdc around next 4 dc, dc in next ch-1 sp, ch 1;







repeat from \* across to last ch-sp, sc in last ch-sp, dc in 2nd ch of turning ch.

**Row 9** Ch 3, turn; \*\*dc in first ch-1 sp, \*FPdc around next 4 dc, ch 1, sk next dc, sc in next ch-1 sp, ch 4, sc in next ch-4 sp, ch 1, dc in next ch-1 sp; repeat from \* across to last 4 dc, BPdc around next 3 dc, dc in last dc.

**Row 10** Ch 2, turn; \*\*FPdc around next 4 dc, \*dc in next ch-1 sp, ch 1, sc in next ch-4 sp, ch 4, sc in next ch-1 sp, ch 1, sk next dc, FPdc around next 4 dc; repeat from \* across to last ch-sp, dc in last ch-sp, dc in 2nd ch of turning ch.

Repeat Rows 1–10 for Diagonal Lace Pattern.

**SIZES**

S (M/L, 1X, 2X/3X)

**FINISHED MEASUREMENTS**

**chest** 36 (44, 50, 56)\*/96.5 (112, 127, 142)cm

**length** 22 (23, 23½, 24½)\*/56 (58.5, 59.5, 62)cm

**GAUGE**

13 sts and 9½ rows = 4"×10cm over Diagonal Lace Pattern

*Remember to check gauge for best results!*

**HOW TO MAKE A GAUGE SWATCH**

Ch 18.

**Row 1** (set-up row) Dc in 3rd ch from hook (beginning ch counts as first dc), dc in next 4 ch, \*ch 1, sk next ch, sc in next ch, ch 4, sk next ch, sc in next ch, ch 1, sk next ch, dc in last 6 ch—17 sts (consisting of 12 dc, 2 sc, 2 ch-1 sps, and 1 ch-4 sp; note Each ch-sp counts as one st only).

**Rows 2–10** Work Rows 1–9 of Diagonal Lace Pattern.

Resulting gauge swatch should measure approx 5¼ x 4¼"/13.5 x 11cm. If necessary, adjust hook size to obtain correct gauge.

**NOTE**

Each ch-space counts as one stitch only, unless otherwise noted. This is particularly important when counting stitches and working increases or decreases. Turning chains count as the number of stitches indicated (e.g., a ch-2 turning chain counts as one double crochet).

**BACK**

Ch 58 (68, 78, 88).

**Row 1** (set-up row) Dc in 3rd ch from hook (beginning ch counts as first dc), dc in next 4 ch, \*ch 1, sk next ch, sc in next ch, ch 4, sk next ch, sc in next ch, ch 1, sk next ch, dc in next 5 ch; repeat from \* across, dc in last ch—57 (67, 77, 87) sts (counting each ch-sp as one st only).

**Rows 2–29** Beginning with Row 1 of pattern, work in Diagonal Lace Pattern until piece measures 12"/30.5cm from beginning; end with Row 8 of Diagonal Lace Pattern.

**Row 30** (increase row) Ch 2, turn; dc in first dc (increase made), ch 1, beginning at \*\* work Row 9 of Diagonal Lace Pattern across to last dc, 2 dc in last dc—59 (69, 79, 89) sts.

**Row 31** Ch 2, turn; FPdc around next dc, beginning at \*\* work Row 10 Diagonal Lace Pattern across to last 2 dc, FPdc around next dc, dc in last dc.

**Row 32** Ch 2, turn; BPdc around next dc,

beginning at \*\* work Row 1 of Diagonal Lace Pattern across to last 2 dc, BPdc around next dc, dc in last dc.

**Row 33** Ch 2, turn; FPdc around next dc, beginning at \*\* work Row 2 Diagonal Lace Pattern across to last 2 dc, FPdc around next dc, dc in last dc.

**Row 34** Ch 2, turn; BPdc around next dc, beginning at \*\* work Row 3 of Diagonal Lace Pattern across to last 2 dc, BPdc around next dc, dc in last dc.

**Row 35** (increase row) Ch 2, turn; dc in first dc (increase made), FPdc around next dc, beginning at \*\* work Row 4 of Diagonal Lace Pattern across to last 2 dc, FPdc around next dc, 2 dc in last dc—61 (71, 81, 91) sts.

**Shape Armholes**

**Row 36** Ch 1, turn; sl st in first 4 dc, work Row 7 of Diagonal Lace Pattern across to last 5 sts, ch 3, dc in last ch-4 sp; leave remaining 4 sts unworked—53 (63, 73, 83) sts.

**DIAGONAL LACE PATTERN STITCH DIAGRAM**

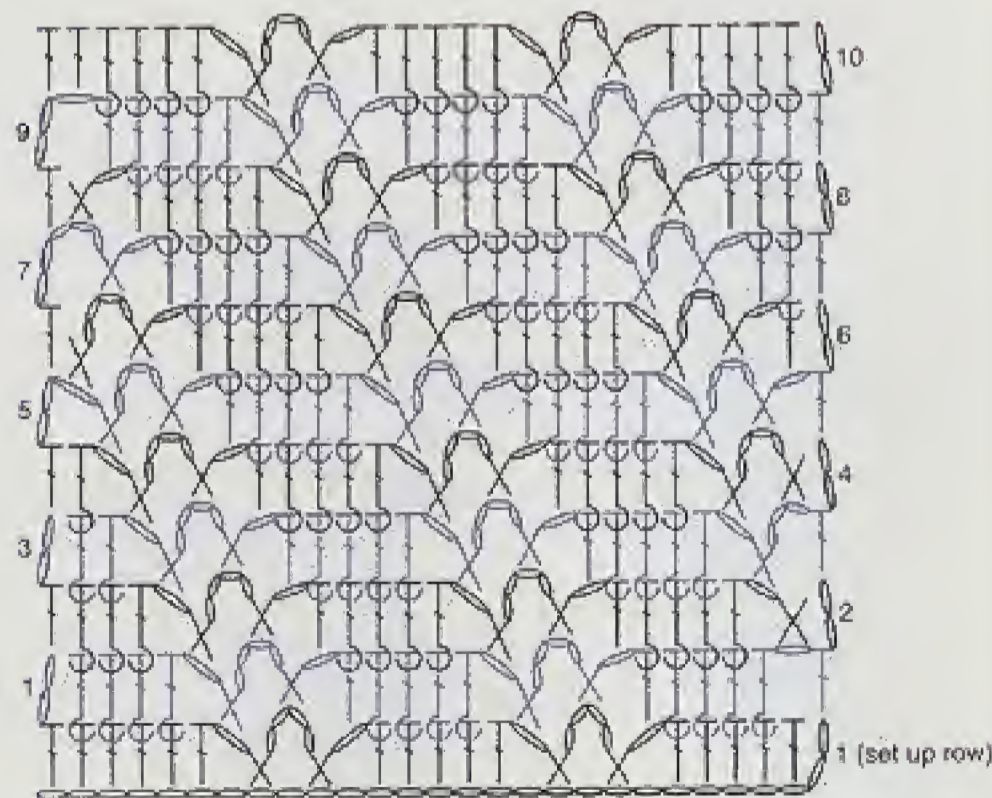



**Sizes M/L (1X, 2X/3X) Only**

**Row 37** (decrease row) Ch 2, turn; sk first ch-sp; beginning at \* work Row 2 of Diagonal Lace Pattern across to last 4 sts, dc2tog over next ch-1 sp and next sc, sk next ch-sp, dc in 2nd ch of turning ch—59 (69, 79) sts.

**Sizes 1X (2X/3X) Only**

**Row 38** (decrease row) Ch 2, turn; sk next dc, dc2tog over next 2 dc, BPdc around next dc, \*ch 1, sk next dc; sc in next ch-1 sp, ch 4, sc in next ch-4 sp, ch 1, dc in next ch-1 sp, BPdc around next 4 sts; repeat from \* across to last 4 sts, sk next dc, dc2tog over next ch-1 sp and next sc, dc in last dc—65 (75) sts.

**Row 39** (decrease row) Ch 2, turn; sk next dc, dc2tog over next 2 dc, FPdc around next 3 dc, dc in next ch-1 sp, ch 1, sc in next ch-4 sp, ch 4, \*sc in next ch-1 sp, ch 1, sk next dc, FPdc around next 4 dc, dc in next ch-1 sp, ch 1, sc in next ch-4 sp, ch 4; repeat from \* across to last 4 sts, dc2tog over next ch-1 sp and next dc, sk next dc, dc in last dc—61 (71) sts.

**Size 2X/3X Only**

**Row 40** (decrease row) Ch 2, turn; sk next dc, dc2tog over next ch-4 sp and sc, dc in next ch-1 sp, \*BPdc around next 4 sts, ch 1, sk next dc, sc in next ch-1 sp, ch 4, sc in next ch-4 sp, ch 1, dc in next ch-1 sp; repeat from \* to last 6 sts, BPdc around next 2 sts, dc2tog over next 2 dc, sk next dc, dc in last dc—67 sts.

**Row 41** (decrease row) Ch 2, turn; sk next dc, dc2tog over next 2 dc, FPdc around next dc, dc in next ch-1 sp, ch 1, sc in next ch-4 sp, ch 4, sc in next ch-1 sp, ch 1, sk next dc, \*FPdc around next 4 dc, dc in next ch-1 sp, ch 1, sc in next ch-4 sp, ch 4, sc in next ch-1 sp, ch 1, sk next dc; repeat from \* across to last 6 sts, FPdc around next 2 sts, dc2tog over next 2 dc, sk next dc, dc in last dc—63 sts.

**All Sizes**

**Row 37 (38, 40, 42)** Work Row 4 (1, 7, 3) of Diagonal Lace Pattern across, end row as in Row 8 (3, 1, 9) of pattern.

**Row 38 (39, 41, 43)** Work Row 9 (4, 2, 10)

of Diagonal Lace Pattern across, end row as in Row 5 (2, 8, 4) of pattern.

Continue in Diagonal Lace Pattern as established, with no increases or decreases, until armhole measures 7 (8, 8½, 9)"/18 (20.5, 21.5, 24)cm. Fasten off.

**FRONT**

Work same as back until 45 (46, 46, 47) rows have been worked. The armhole should measure approx 4 (4½, 4½, 5)"/10 (11.5, 11.5, 12.5) cm, and the last row worked should begin as in Row 2 (9, 3, 4) and end as in Row 6 (1, 7, 7) of Diagonal Lace Pattern.

**Shape First Shoulder and Neck**

Place a marker in st on each side of center 17 (19, 21, 23) sts.

**Row 46 (47, 47, 48)** Work Row 7 (2, 8, 8) of Diagonal Lace Pattern across to marked st, dc in marked st—18 (20, 20, 20) sts.

**Row 47 (48, 48, 49)** (decrease row) Ch 1, turn; sl st in first 3 sts, ch 2 (counts as dc).

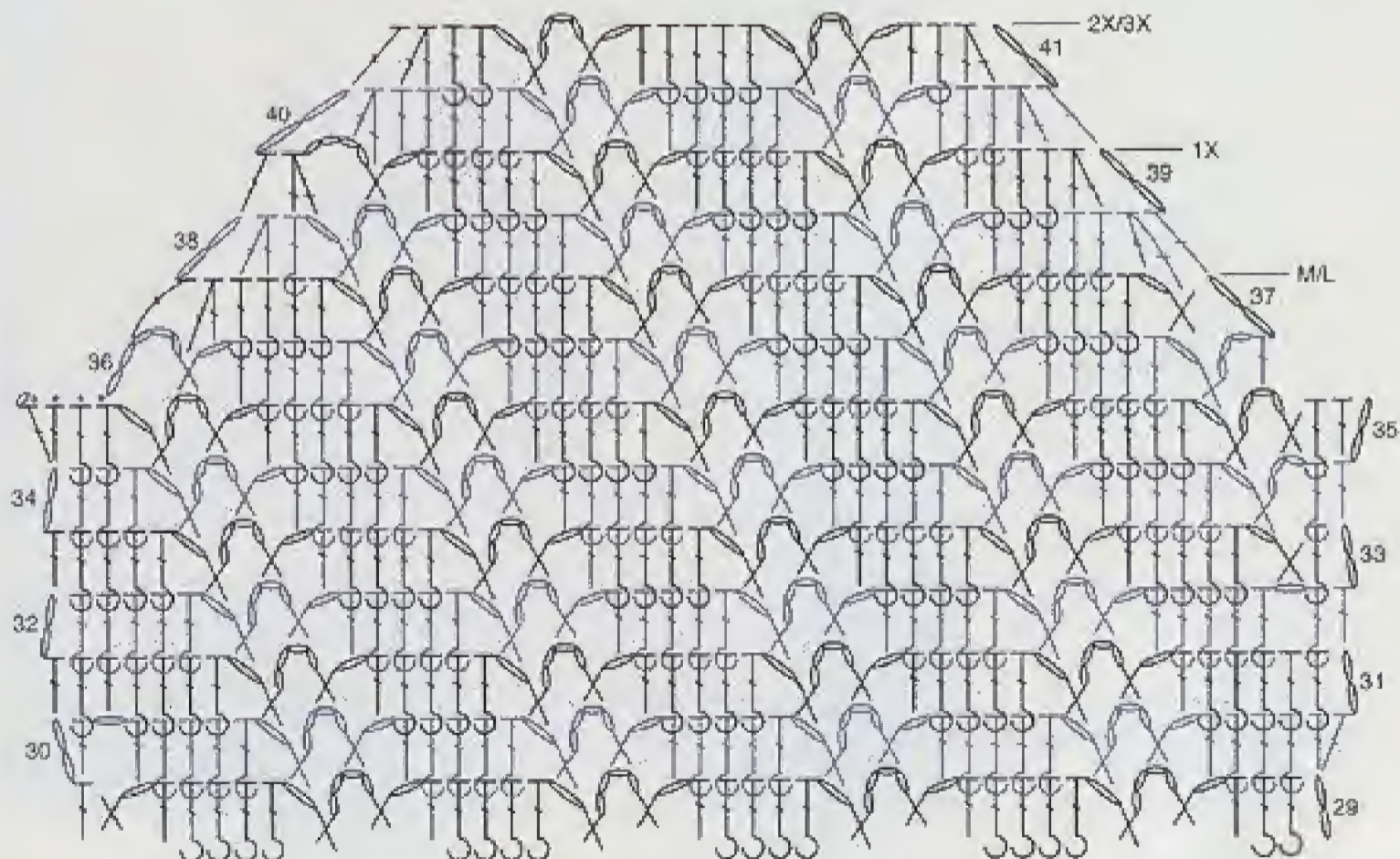
**INCREASE AND DECREASE STITCH PATTERN FOR BACK ROWS 29-41**



beginning at \*\* work Row 6 (3, 9, 9) of Diagonal Lace Pattern, end as in Row 8 (3, 9, 9) of pattern—15 (17, 17, 17) sts.

**Row 48 (49, 49, 50)** (decrease row) Work Row 9 (4, 10, 10) of Diagonal Lace Pattern across to last 3 sts, dc in next dc; leave remaining 2 sts unworked—13 (15, 15, 15) sts.

**Row 49 (50, 50, 51)** Work Row 8 (7, 3, 3) of Diagonal Lace Pattern across, end row as in Row 10 (5, 1, 1).

Continue in Diagonal Lace Pattern as established, with no increases or decreases, until armhole measures the same as back armhole. Fasten off.

#### Shape Second Shoulder and Neck

Join yarn with sl st in next marked st.

**Next Row** Ch 2, continue in Diagonal Lace Pattern as established across—18 (20, 20, 20) sts.

**Next Row** Ch 2, turn; continue in Diagonal Lace Pattern as established across to last 4 sts, dc in next st; leave remaining 3 sts unworked—15 (17, 17, 17) sts.

**Next Row** Ch 1, turn; sl st in first 2 sts, ch 2 (counts as dc), sk next st, continue in Diagonal Lace Pattern as established, work dc in last dc—13 (15, 15, 15) sts.

Continue in Diagonal Lace Pattern as established, with no increases or decreases, until armhole measures the same as back armhole. Fasten off.

#### (SLEEVE (MAKE 2))

Ch 32.

**Row 1** (set-up row) Dc in 3rd ch from hook (beginning ch counts as dc) and in next ch, ch 1, sk next ch, sc in next ch, ch 4, sk next ch, sc in next ch, ch 1, sk next ch, \*dc in next 5 ch, ch 1, sk next ch, sc in next ch, ch 4, sk next ch, sc in next ch, ch 1, sk next ch; repeat from \* across to last 3 ch, dc in last 3 ch—31 sts.

**Row 2** Ch 2, turn; BPdc around next dc, \*\*ch 1, sk next dc, sc in next ch-1 sp, ch 4, sc in next ch-4 sp, ch 1, dc in next ch-1 sp, \*BPdc around next 4 dc, ch 1, sk next dc, sc in next ch-1 sp, ch 4, sc in next ch-4 sp, ch 1, dc in next ch-1 sp; repeat from \* across to last 3 dc, BPdc around next 2 dc, dc in last dc.

**Row 3** (increase row) Ch 2, turn; dc in first

dc (increase made), \*\*FPdc around each dc to first ch-1 sp, dc in next ch-1 sp, ch 1, sc in next ch-4 sp, ch 4, sc in next ch-1 sp, ch 1, sk next dc, \*FPdc around next 4 dc, dc in next ch-1 sp, ch 1, sc in next ch-4 sp, ch 4, sc in next ch-1 sp, ch 1, sk next dc; repeat from \* across to last group of dc, end with FPdc around each dc to last, 2 dc in last dc—33 sts.

**Row 4** Ch 2, turn; BPdc around each dc across to 1 dc before first ch-1 sp, beginning at \*\* repeat Row 2 across, ending with BPdc around each dc to last dc, dc in last dc.

#### Sizes 5 Only

**Row 5** Ch 2, turn; beginning at \*\* repeat Row 3 across.

**Row 6** Repeat Row 4.

#### All Sizes

Repeat last 4 (2, 2, 2) rows 6 (9, 11, 14) more time(s)—45 (51, 55, 61) sts.

**Note** Work increased stitches into Diagonal Lace Pattern if desired.

Continue in Diagonal Lace Pattern as established, working no increases, until sleeve measures 17"/43cm from the beginning.







**Shape Cap**

**Next Row** Ch 1, turn; sl st in first 4 sts, ch 2 (counts as dc), sk next st, continue in Diagonal Lace Pattern as established across to last 5 sts, dc in next st; leave remaining sts unworked—37 (43, 47, 53) sts.

**Next Row** (decrease row) Ch 2, turn; sk next st, continue in Diagonal Lace Pattern as established across to last 2 sts, dc2tog—35 (41, 45, 51) sts.

Repeat last row 13 (15, 17, 19) more times—9 (11, 11, 13) sts.

Fasten off.

**FINISHING**

Steam pieces very lightly. Sew shoulder seams. Sew side and sleeve seams. Sew sleeves into armholes.

**Edging**

Join yarn with sc in seam at cuff edge, sc evenly spaced around; join with sl st in first sc. Fasten off. Repeat edging around other cuff, neck edge, and lower edge.

Weave in all ends.

*Tip*

Refer to the stitch diagram frequently to ensure that you keep working in the Diagonal Lace Pattern "as established."

**SCHEMATICS**

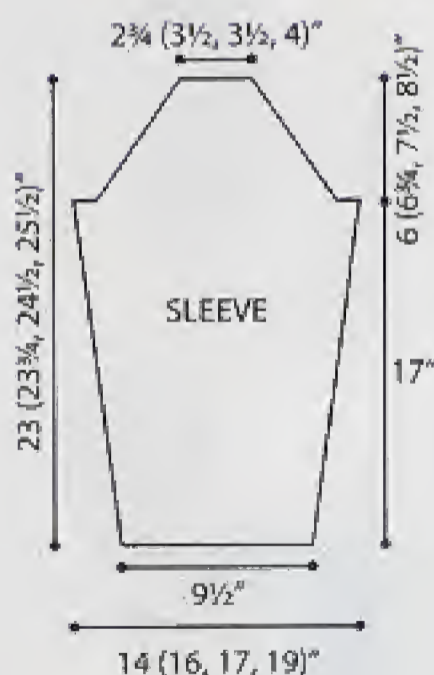
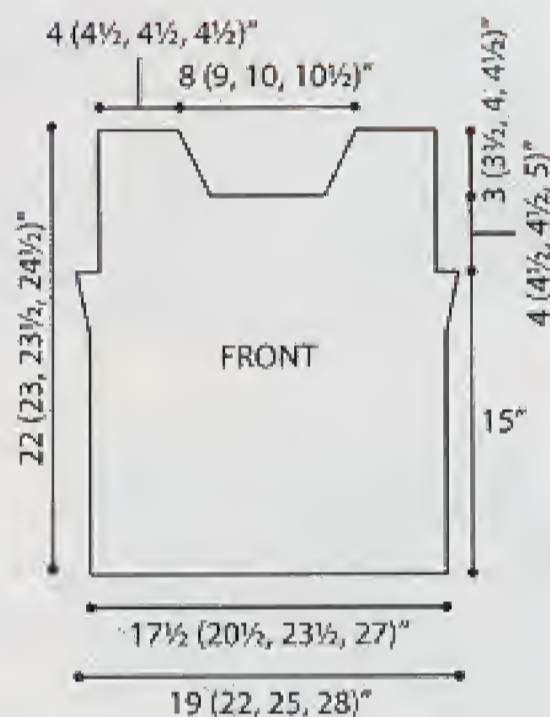
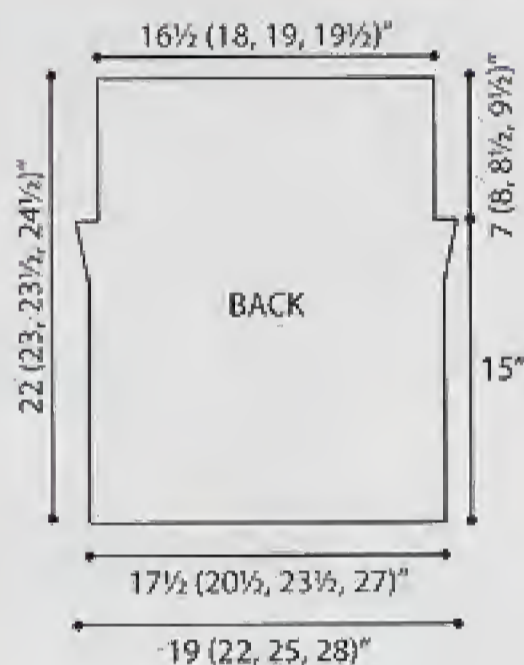









# Snowfall Cowl

Take the chill off with this lush cowl, which works up fast in bulky yarn and a large hook. We love it over a sweater or under a winter coat.

By Robyn Chachula

## What You'll Need

### YARN

RED HEART Light & Lofty, 6oz/170g balls, each approx 140yd/128m (acrylic)

- 1 ball #9316 Puff

### KNITTING HOOK

- Size M/13 (9mm) crochet hook or any size to obtain correct gauge

### MATERIALS

- 4 buttons—3½"/22mm diameter
- Sewing thread to match buttons
- Yarn needle

Skill Level: Easy

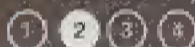

## ABBREVIATIONS USED IN THIS PATTERN

- ch chain      sp space  
 sc single crochet      tr treble crochet  
 \* Repeat directions following \* as many times as indicated.

## SPECIAL ABBREVIATION

**dtr** (double treble crochet) [Yarn over] 3 times, insert hook in indicated stitch or space, yarn over and draw up a loop, [yarn over and draw through 2 loops on hook] 4 times.

the yarn

Light & Lofty in Puff



## FINISHED MEASUREMENTS

Approx 26"/66cm circumference and 6½"/16.5cm wide

## GAUGE

8½ sts and 4 rows = 4"/10cm over pattern. Remember to check gauge for best results!

## HOW TO MAKE A GAUGE SWATCH

Ch 10.

**Rows 1–7** Work Rows 1–7 of Cowl—9 sts.

Resulting gauge swatch should measure approx 4¼ x 7"/11 x 18cm. If necessary, adjust hook size to obtain correct gauge.

## COWL

Ch 15.

**Row 1** (wrong side) Sc in 2nd ch from hook and in each remaining ch across—14 sts.

**Row 2** Ch 4 (counts as tr), turn, tr in each sc across.

**Row 3** Ch 1, turn, sc in first tr, sc in sp between first and 2nd tr, \*sc in sp between next 2 tr, repeat from \* across, working last sc in sp between last tr and turning ch.

**Rows 4 and 5** Repeat Rows 2 and 3.

**Row 6** Ch 5 (counts as dtr), turn, dtr in each sc across.

**Row 7** Ch 1, turn; sc in first dtr, sc in sp between first and 2nd dtr, \*sc in sp between next 2 dtr, repeat from \* across, working last sc in sp between last dtr and turning ch. Repeat Rows 2–7 three more times. Fasten off.

## Finishing

Weave in all ends. With yarn needle and yarn, whipstitch short edges together. With yarn needle and sewing thread, sew buttons to the first row for decoration.

## try this!

Make the cowl match your coat in Light & Lofty in #9380 Antique Blue or #9617 Pheasant

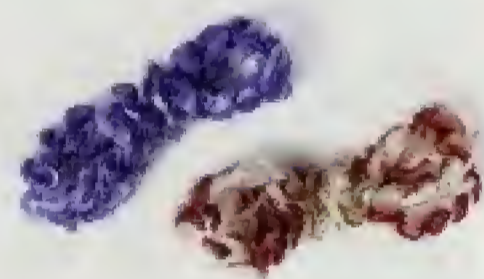

## Tip

To make this yarn easier to work with, use an aluminum hook and keep your tension loose.

## STITCH DIAGRAM

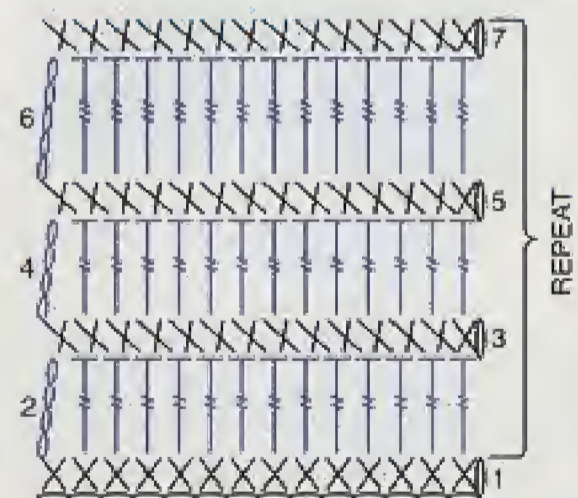



# Capelet Swing Cardigan

This sweater is completely customizable: Crocheted from the top down, you can work it to any length. Try it on as you go to get the perfect fit.

By Mari Lynn Patrick

## What You'll Need

### YARN

RED HEART Eco-Ways, 4oz/113g balls, each approx 186yd/170m (acrylic/recycled polyester)

- 7 (9, 10) balls #3313 Oyster

### CROCHET HOOK

- Size H/8 (5mm) crochet hook or any size to obtain correct gauge

### NOTIONS

- 2 buttons—1½"38mm diameter (for outer buttons)
- 1 button—1"25mm diameter (for inner button)
- Stitch markers
- Yarn needle

Skill Level: Intermediate

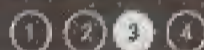

## ABBREVIATIONS USED IN THIS PATTERN

- |     |                     |       |             |
|-----|---------------------|-------|-------------|
| ch  | chain               | sk    | skip        |
| dc  | double crochet      | sl st | slip stitch |
| hdc | half double crochet | sp(s) | space(s)    |
| sc  | single crochet      | st(s) | stitch(es)  |
- [ ] Work directions in brackets number of times indicated.  
 ( ) Work directions in parentheses into stitch indicated.  
 \* Repeat directions following \* as many times as indicated.

the yarn



Eco-Ways in Oyster

## SIZES

S/M (L/X, 2X/3X)

## FINISHED MEASUREMENTS

chest/waist 37 (46, 53)"/94 (117, 134.5)cm  
 length 36"/91.5cm

**Note** Coat fits a large range of sizes. Snuggest part of coat fits below bust (high waist). Fit is customized by overlapping front edges and placing buttons carefully. S/M will fit busts approx 34–40"/86.5–101.5cm, L/X will fit busts approx 42–50"/106.5–127cm, 2X/3X will fit busts approx 50–56"/127–142cm.

## GAUGE

7 (sc, dc) repeats and 11½ rows = 4"/10cm over (sc, dc) pattern.

*Remember to check gauge for best results!*

## HOW TO MAKE A GAUGE SWATCH

Ch 30.

**Row 1** (wrong side) (Sc, dc) in 2nd ch from hook, \*sk next ch, (sc, dc) in next ch; repeat from \* across—15 (sc, dc) pattern repeats.

**Rows 2–23** Ch 1, turn; (sc, dc) in first st, \*sk next st, (sc, dc) in next st; repeat from \* across. Resulting gauge swatch should measure approx 8 x 8"/20.5 x 20.5cm. If necessary, adjust hook size to obtain correct gauge.

## NOTES

**1** This design can be worked in a variety of styles: coat, long jacket, short jacket, or capelet only. The capelet is worked first from the center front edges around using "short rows" to form the curved shape. Then the body is worked downward, and it can be tried on while working to desired length.

**2** To make a long jacket (about 28"/71cm long), you will need one less ball of yarn. To make a short jacket (about 22"/56cm long),

you will need two fewer balls of yarn. To make the capelet only you will need three fewer balls of yarn.

## CAPELET

Beginning at one center front edge, ch 56.

**Row 1** (wrong side) (Sc, dc) in 2nd ch from hook, \*sk next ch, (sc, dc) in next ch; repeat from \* across—28 (sc, dc) pattern repeats.

**Rows 2–22** Ch 1, turn, (sc, dc) in first st, \*sk next st, (sc, dc) in next st; repeat from \* across.

## Begin "Short Row" Shaping

**Short Row 1** (right side) Ch 1, turn; (sc, dc) in first st, (sk next st, (sc, dc) in next st) 6 times; leave remaining sts unworked—7 (sc, dc) pattern repeats.

**Short Row 2** Ch 1, turn; (sc, dc) in first st, \*sk next st, (sc, dc) in next st; repeat from \* across.

**Short Row 3** Ch 1, turn; (sc, dc) in first st, \*sk next st, (sc, dc) in next st; repeat from \* across; working in unworked st of previous row (sk next st, (sc, dc) in next st) 7 times; leave remaining sts unworked—14 (sc, dc) pattern repeats.

**Short Rows 4 and 5** Repeat Short Rows 2 and 3—21 (sc, dc) pattern repeats.

**Short Row 6** Repeat Short Row 2.

**Short Row 7** Ch 1, turn; (sc, dc) in first st, \*sk next st, (sc, dc) in next st; repeat from \* across; working in unworked st of previous row (sk next st, (sc, dc) in next st) 6 times; leave remaining sts unworked—27 (sc, dc) pattern repeats.

**Short Row 8** Repeat Short Row 2.

**Short Row 9** Ch 1, turn; (sc, dc) in first st, \*sk next st, (sc, dc) in next st; repeat from \* across; working in unworked sts of previous row, sk next st, (sc, dc) in next st—28 (sc, dc) pattern repeats.

**Short Rows 10–12** Ch 1, turn; (sc, dc) in







first st, \*sk next st, (sc, dc) in next st; repeat from \* across.

**Short Rows 13–132 (168, 192)** Repeat last 12 short rows 10 (13, 15) more times.

**Next 19 Rows** Ch 1, turn; (sc, dc) in first st, \*sk next st, (sc, dc) in next st; repeat from \* across.

**Last Row** Ch 1, turn; (sc, dc) in first st, [sk next st, (sc, dc) in next st] 11 times; ch 9, sk next st, sc in next st, place a marker in sc just made; working along ch-9 just made, sc in each ch across (buttonloop made), dc in marked sc, \*sk next st, (sc, dc) in next st; repeat from \* across.

Fasten off.

**Note** This completes the capelet. The shorter of the two long edges forms the neck edge. The longer of the two long edges forms the lower edge.

#### BODY

Notice that the long edges of the capelet (ends of rows) appear “scalloped.” There should be 87 (105, 117) scallops along the lower edge of the capelet.

**Row 1** With right side of capelet facing and working in scallops along lower edge, join yarn with sc in first scallop, [ch 2, sc in next scallop] 15 (19, 23) times, ch 15, sk next 18 (19, 19) scallops (for armhole), sc in next scallop, [ch 2, sc in next scallop] 18 (26, 30) times, ch 15, sk next 18 (19, 19) scallops (for armhole), sc in next scallop, [ch 2, sc in next scallop] 15 (19, 23) times—51 (67, 79) sc, 48 (64, 76) ch-2 sps, and 2 ch-15 sps.

**Row 2** (wrong side) Ch 1, turn; \*(sc, dc) in next sc, \*sk next ch-2 sp, (sc, dc) in next sc; repeat from \* across to armhole ch-15 sp, sk first ch, [(sc, dc) in next ch, sk next ch] 7 times; repeat from \*\* once more, (sc, dc) in next sc, \*\*\*sk next ch-2 sp, (sc, dc) in next sc; repeat from \*\*\* across—65 (81, 93) (sc, dc) pattern repeats.

**Rows 3–14** Ch 1, turn; (sc, dc) in first st, \*sk next st, (sc, dc) in next st; repeat from \* across.

**Row 15** (increase row—right side) Ch 1, turn; (sc, dc) in first st, [sk next st, (sc, dc) in next st] 19 (25, 29) times, do not sk next st, (sc, dc) in next 2 sts (increase made); place a marker in 2nd to last dc just made, [sk next st, (sc, dc) in next st] 11 (13, 15) times, do not sk next st, (sc, dc) in next 2 sts

(increase made), place a marker in last dc just made, [sk next st, (sc, dc) in next st] 11 (13, 15) times, do not sk next st, (sc, dc) in next 2 sts (increase made), place a marker in last dc just made, [sk next st, (sc, dc) in next st] 20 (26, 30) times—68 (84, 96) (sc, dc) pattern repeats.

**Note** Move markers up as work progresses. When working even rows (not increasing), always move the marker to the dc of the (sc, dc) worked into the marked st. To help keep the increases nicely spaced, when moving a marker into an increase, move the marker to the 2nd to last dc just made in the first increase, the last dc just made in the 3rd

increase, and alternate this placement in the middle increase (i.e., place the marker in the 2nd to last dc just made in every other increase row, and in the last dc just made in the other increase rows).

**Rows 16–18** Ch 1, turn; (sc, dc) in first st, \*sk next st, (sc, dc) in next st; repeat from \* across.

**Row 19** (increase row—right side) Ch 1, turn; (sc, dc) in next sc, [\*sk next st, (sc, dc) in next st; repeat from \* across to next marked st, do not sk next st, (sc, dc) in next 2 sts] 3 times, \*\*sk next st, (sc, dc) in next st; repeat from \*\* across—71 (87, 99) (sc, dc) pattern repeats.

**Rows 20–55** Repeat last 4 rows 9 more







lines—98 (114, 126) (sc, dc) pattern repeats.  
**Rows 56–58** Ch 1, turn; (sc, dc) in first st, \*sk next st, (sc, dc) in next st; repeat from \* across.  
**Row 59** Ch 1, turn; (sc, hdc, dc) in first st, \*sk next st, sl st in next st, sk next st, (sc, hdc, dc) in next st; repeat from \* across. Fasten off.

**FINISHING**

**Buttonloops**

Make two buttonloops for outer buttons with one at the right front waist edge (where capelet meets body) and another at right front capelet edge 4"/10cm below top edge as follows:

**Loop Row** Join yarn with sc in edge, ch 9, sc in same sp as first sc, turn, working along ch-9 just made, sc in each ch across (buttonloop made), sl st in first sc. Fasten off.

Work another buttonloop, in same manner, on left front edge of capelet, 4"/10cm below top edge (for inner button). Try on coat and place markers on coat to correspond to buttonloops (one each for buttonloop at right front edge, left front edge, and waist). Sew buttons at marked locations.

**Back Neck**

To stabilize back neck, place a marker on each side of the center 5"/12.5cm at back neck, 3"/7.5cm below top edge. Working from wrong side around posts of sts at center back neck, work 14 sc evenly spaced between the markers. Ch 1, turn; sc in each of the 14 sc across. Fasten off.

Weave in all ends...

try this!

Make this fashion-forward coat in bold solids, too: #3533 Misty Violet or #3344 Bark



**SCHEMATIC**

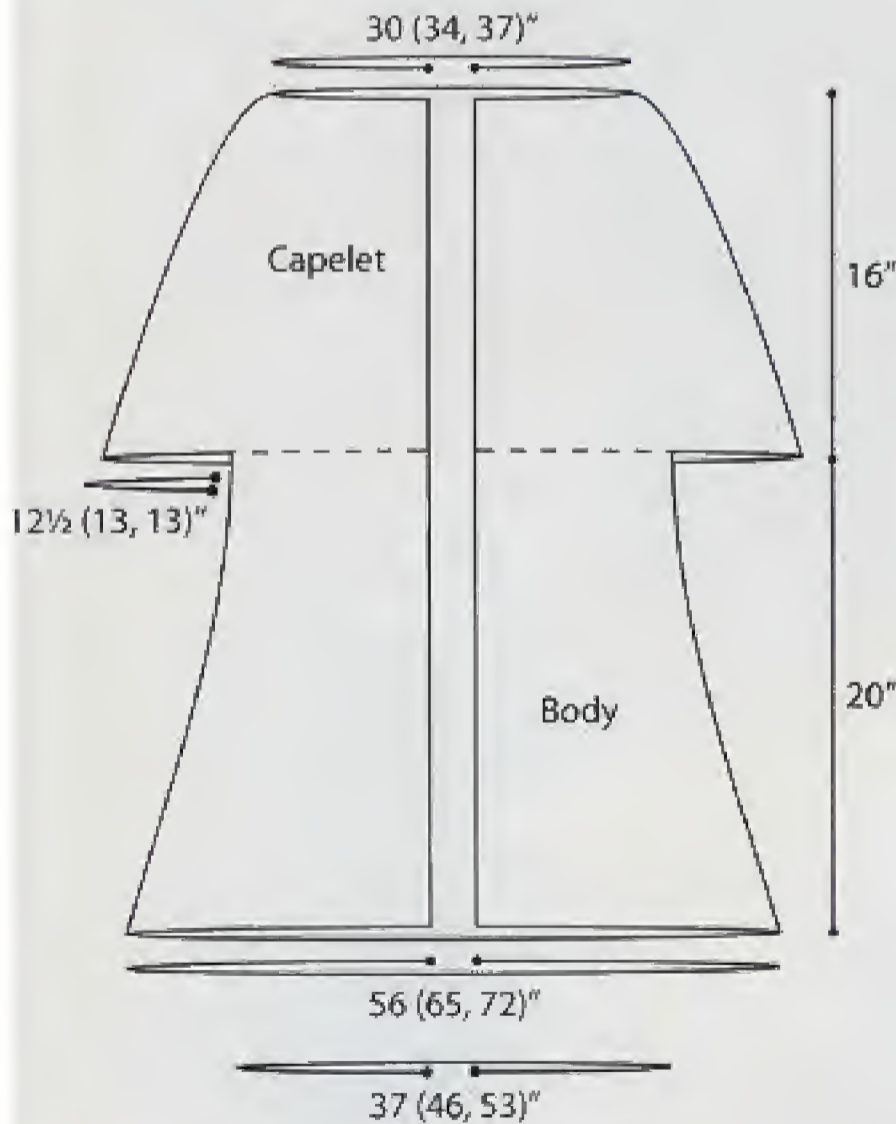

**STITCH DIAGRAMS**

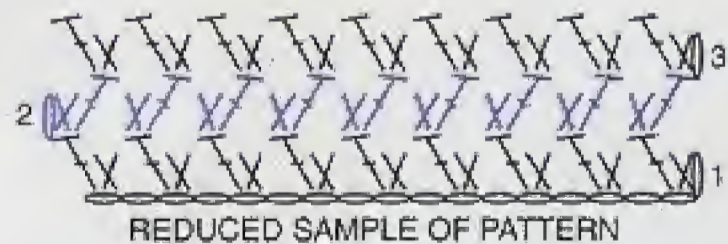
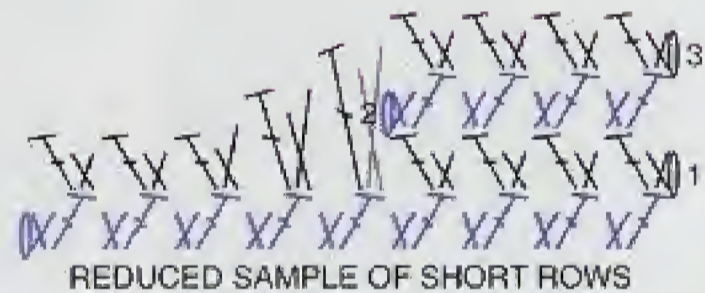



# Snowflake Earrings

Excerpted from Linda Permann's book *Crochet Adorned*, these dainty earrings work up quickly and make great gifts. They're a great project for trying your hand at thread crochet.

By Linda Permann



## What You'll Need

### YARN

AUNT LYDIA'S Classic Crochet Thread, Size 10, each ball approx 350yd/320m (cotton)

- 1 ball #226 Natural

**Note** Many pairs of earrings can be made from a single ball of thread.

### CROCHET HOOK

- Size 7 (1.65mm) steel crochet hook or any size to obtain correct gauge

### NOTIONS

- 1 pair of ear wires (per pair of earrings)
- Flat-nose pliers
- Yarn needle

Skill Levels: Intermediate



## ABBREVIATIONS (SEE IN FRONT MATTER)

ch chain                      sl st slip stitch  
dc double crochet        sp(s) space(s)  
hdc half double crochet    st(s) stitch(es)  
sc single crochet

[ ] Work directions in brackets number of times indicated.

( ) Work directions in parentheses into stitch or space indicated.

## ADJUSTABLE RING METHOD

**adjustable ring method** Holding the yarn a few inches from the end, wrap around your finger. Do not remove wrap from finger. Insert hook into the wrap and draw up a loop of working yarn. Work number of chains indicated to secure the loop, and remove ring from finger. Work stitches of first round in the rings. Pull gently, but firmly, on tail to tighten ring.

## FINISHED MEASUREMENTS

**dolly earring** Approx 1/4"76.5mm diameter

**leaf earring** Approx 1 1/2"38mm long

## GUAGE

Use finished measurements for gauge.

*Remember to check gauge for best results!*

## DOLLY EARRING (MAKE 2)

Make an adjustable ring.

**Round 1** (right side) Ch 3 (counts as hdc, ch 1), [hdc in ring, ch 1] 9 times; join with sl st in 2nd ch of beginning ch—10 hdc and 10 ch-1 sps.

**Round 2** Ch 5 (counts as sc, ch 4), [sc in next hdc, ch 4] 9 times; join with sl st in first ch of beginning ch—10 sc and 10 ch-4 sps.

**Round 3** Sl st in next 2 ch, ch 5 (counts as sc, ch 4), [sc in next ch-4 sp, ch 4] 9 times; join with sl st in first ch of beginning ch. Fasten off and weave in ends.

## LEAF EARRING (MAKE 2)

Ch 8.

**Round 1** (right side) Sc in 2nd ch from hook, hdc in next 2 ch, dc in next 3 ch, 8 dc in last ch; pivot piece to work along opposite side of foundation ch, dc in next 3 ch, hdc in next 2 ch, sc in next ch; join with sl st in first sc—20 sts.

**Round 2** Ch 1, sc in same sc as join, sc in next 6 sts, 2 sc in next 6 sts, sc in last 7 sts, ch 1; join with sl st in first sc—26 sc, and 1 ch-1 sp.

**Round 3** (wrong side) Turn; ch 2 (counts as hdc), sl st in same sc as join, (hdc, sl st) in next ch-1 sp, (hdc, sl st) in each sc around; join with sl st in base of beginning ch—27 hdc. Fasten off and weave in ends.

## FINISHING

With flat-nosed pliers, grasp one half of the wire earring loop and turn it out about 45 degrees. Slip the loop into the stitch in the top center of each leaf earring. For the dolly earrings, slip the loop through any ch-4 sp of last round. Close the loop.

## the yarn

Classic Crochet Thread  
in Natural

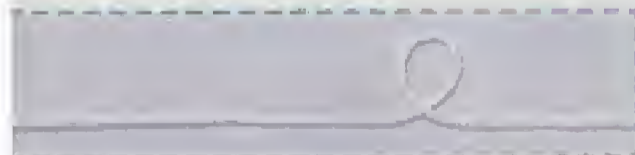







DOILY STITCH DIAGRAM

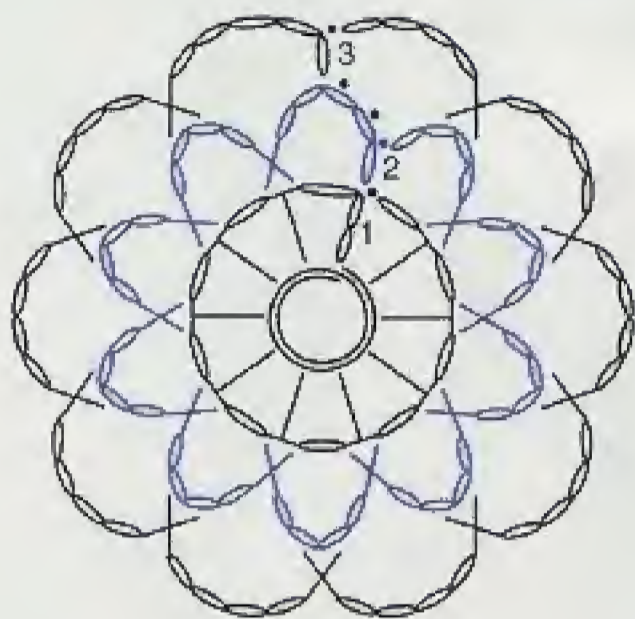

LEAF STITCH DIAGRAM

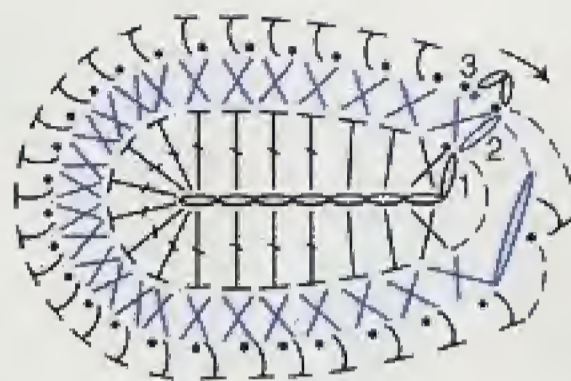

... If you're into beading, try combining these pieces with beads and chain for an eclectic look.

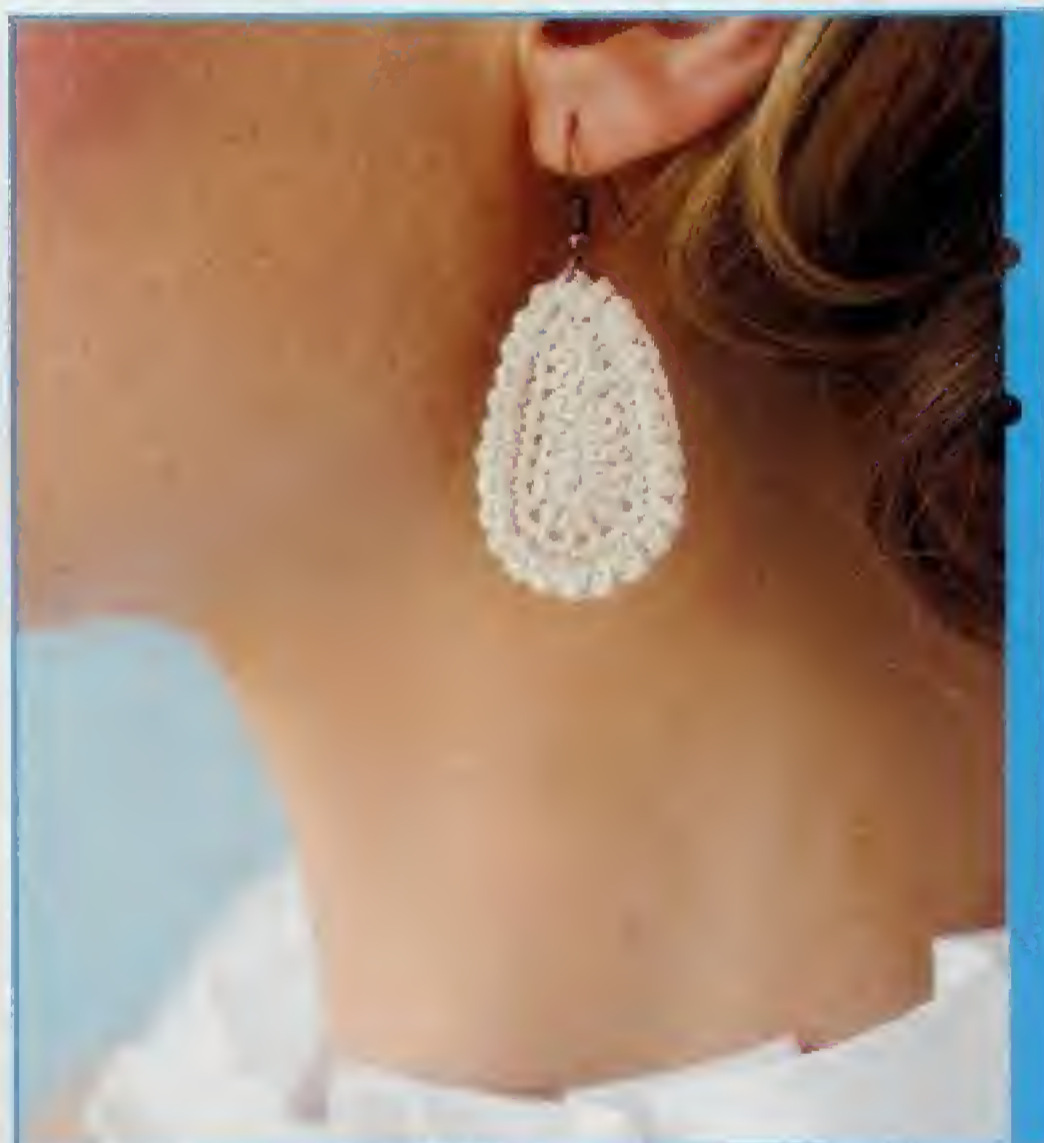

Reprinted from the book CROCHET  
 ADORES by LINDA PERMANN  
 Copyright © 2009 by LINDA PERMANN  
 MANN, Published by Power Grid, a  
 division of Random House, Inc.



# Visions of Sugarplums

**S**titch something sweet for baby with our collection of candy-colored goodies. From yummy booties and mittens to a delectable sweater and a blanket that's as light as cotton candy, there's plenty here for little ones—so whip something up. *©dorty.spit!*

Sweet booties P70









# Candyland Sweater

Sugar and spice and everything nice, that's what this little cardigan is made of! Stitch it for a sweet girl on your gift list.

By Robyn Chachula

## ABBREVIATIONS USED IN THIS PATTERN

**ch(s)** chain(s)      **sl st** slip stitch  
**hdc** half double crochet      **sp(s)** space(s)  
**sc** single crochet      **st(s)** stitch(es)  
**sk** skip

\* Repeat directions following \* as many times as indicated.

[ ] Work directions in brackets number of times indicated.

( ) Work directions in parentheses into stitch indicated.

## SPECIAL ABBREVIATIONS

**shell** (2 dc, ch 2, 2 dc) in indicated stitch or space.

**surface slip stitch** Make a slip knot, but do not place it on hook. Hold slip knot on wrong side of fabric. Insert hook from right side of fabric through to wrong side. Place slip knot on hook, draw loop to right side. Insert hook from right side to wrong side through next desired stitch or space, yarn over, draw loop to right side and through loop on hook (surface slip stitch made). To end a line of surface slip stitches, draw up a loop on the right side of fabric. Remove hook from loop and take hook to wrong side of fabric. Insert hook from wrong side to right side, place loop on hook, draw loop through to wrong side of fabric. Fasten off leaving a long tail. Draw tail through final loop and pull tight.

## What You'll Need

### YARN

TLC Baby Amore, 5oz/140g skeins, each approx 279yds/255m (acrylic)

- 1 (2, 2, 3) skeins #9594 Aqua (A)
- 1 skein #9001 White (B)

**Note** Less than a third of skein B is needed

### CROCHET HOOK

- Size I/9 (5.5mm) crochet hook of any size to obtain correct gauge

### MATERIALS

- 2 buttons— $\frac{3}{4}$ "/19mm diameter
- Sewing needle and matching thread
- Stitch markers
- Yarn needle

Skill Level: Intermediate



Baby Amore in Aqua



crochet today! 61



**FANCY STITCH PATTERN**

**Row 1** Ch 3 (counts as dc), turn; 2 dc in first hdc, (sc, ch 3, sc) in ch-2 sp of next shell, \*shell in next ch-3 sp, (sc, ch 3, sc) in ch-2 sp of next shell; repeat from \* across. 3 dc in 2nd ch of turning ch.

**Row 2** Ch 3, sc in first dc, shell in next ch-3 sp, \*(sc, ch 3, sc) in ch-2 sp of next shell, shell in next ch-3 sp; repeat from \* across, (sc, ch 1, hdc) in top of turning ch.

Repeat Rows 1 and 2 for Fancy Stitch Pattern.

**SIZES**

6 months (1 year, 2 years, 4 years)

**FINISHED MEASUREMENTS**

**chest** 22½ (24½, 28, 30)"/57 (62, 71, 76)cm

**length** 10 (11¼, 12¼, 13½)"/25.5 (28.5, 31, 34.5)cm

**GAUGE**

15 sts = 4"/10cm and 12 rows = 4 ½"/10.5cm over half double crochet; Two (2 dc, ch 2, 2 dc) shells = 3 ¼"/9.5cm and 6 rows = 4"/10cm over Fancy Stitch Pattern.

*Remember to check gauge for best results!*

**HOW TO MAKE A GAUGE SWATCH**

Ch 22.

**Row 1** (right side) Sc in 4th ch from hook, sk next 2 ch, (2 dc, ch 2, 2 dc) in next ch (shell made), sk next 2 ch, ((sc, ch 3, sc) in next ch, sk next 2 ch, shell in next ch, sk next 2 ch) twice, (sc, ch 1, hdc) in last ch.

**Rows 2–8** Beginning with Row 1 of pattern, work 7 rows of Fancy Stitch Pattern—3 shells. Resulting gauge swatch should measure approx 5 ½ x 4"/14.5 x 10cm. If necessary, adjust hook size to obtain correct gauge.

**NOTE**

Sweater is worked from yoke down to underarms. Work is then divided to form armholes, and body is worked from armholes down to lower edge. Sleeves are worked from armholes down to cuff edge.

**YOKE**

With A, ch 50 (60, 60, 70).

**Row 1** Hdc in 3rd ch from hook (beginning ch counts as first hdc), hdc in each remaining ch

across—49 (59, 59, 69) hdc.

**Note** For 6 month and 4 year sizes, Row 1 is the wrong side. For 1 year and 2 year sizes, Row 1 is the right side.

**Row 2** Ch 2 (counts as hdc here and throughout), turn; hdc in next 4 (5, 5, 6) hdc, 2 hdc in next hdc, hdc in next 3 hdc, 2 hdc in next hdc, [hdc in next 2 (3, 3, 4) hdc, 2 hdc in next hdc] 3 times, hdc in next 11 (13, 13, 15) hdc, [2 hdc in next 2 (3, 3, 4) hdc, 2 hdc in next hdc] 3 times, 2 hdc in next hdc, hdc in next 3 hdc, 2 hdc in next hdc, hdc in last 5 (6, 6, 7) hdc—59 (69, 69, 79) hdc.

**Row 3** Ch 2, turn; hdc in next 4 (5, 5, 6) hdc, 2 hdc in next hdc, hdc in next 4 hdc, 2 hdc in next hdc, [hdc in next 3 (4, 4, 5) hdc, 2 hdc

in next hdc] 3 times, hdc in next 13 (15, 15, 17) hdc, [2 hdc in next 3 (4, 4, 5) hdc, 2 hdc in next hdc] 3 times, 2 hdc in next hdc, hdc in next 4 hdc, 2 hdc in next hdc, hdc in last 5 (6, 6, 7) hdc—69 (79, 79, 89) hdc.

**Row 4** Ch 2, turn; hdc in next 5 (6, 6, 7) hdc, 2 hdc in next hdc, hdc in next 5 hdc, 2 hdc in next hdc, [hdc in next 4 (5, 5, 6) hdc, 2 hdc in next hdc] 3 times, hdc in next 13 (15, 15, 17) hdc, [2 hdc in next 4 (5, 5, 6) hdc, 2 hdc in next hdc] 3 times, 2 hdc in next hdc, hdc in next 5 hdc, 2 hdc in next hdc, hdc in last 6 (7, 7, 8) hdc—79 (89, 89, 99) hdc.

**Row 5** Ch 2, turn; hdc in next 5 (6, 6, 7) hdc, 2 hdc in next hdc, hdc in next 5 (6, 6, 7) hdc, 2 hdc in next hdc, hdc in next 12 (13, 13, 14)







hdc, 2 hdc in next hdc, hdc in next 5 (6, 6, 7) hdc, 2 hdc in next hdc, hdc in next 15 (17, 17, 19) hdc, 2 hdc in next hdc, hdc in next 5 (6, 6, 7) hdc, 2 hdc in next hdc, hdc in next 12 (13, 13, 14) hdc, 2 hdc in next hdc, hdc in next 5 (6, 6, 7) hdc, 2 hdc in next hdc, hdc in last 6 (7, 7, 8) hdc—87 (97, 97, 107) hdc.

**Row 6** Ch 2, turn; hdc in next 6 (7, 7, 8) hdc, 2 hdc in next hdc, hdc in next 6 (7, 7, 8) hdc, 2 hdc in next hdc, hdc in next 13 (14, 14, 15) hdc, 2 hdc in next hdc, hdc in next 6 (7, 7, 8) hdc, 2 hdc in next hdc, hdc in next 15 (17, 17, 19) hdc, 2 hdc in next hdc, hdc in next 6 (7, 7, 8) hdc, 2 hdc in next hdc, hdc in next 13 (14, 14, 15) hdc, 2 hdc in next hdc, hdc in next 6 (7, 7, 8) hdc, 2 hdc in next hdc, hdc in last 7 (8, 8, 9) hdc—95 (105, 105, 115) hdc.

**Row 7** Ch 2, turn; hdc in next 6 (7, 7, 8) hdc, 2 hdc in next hdc, hdc in next 7 (8, 8, 9) hdc, 2 hdc in next hdc, hdc in next 14 (15, 15, 16) hdc, 2 hdc in next hdc, hdc in next 7 (8, 8, 9) hdc, 2 hdc in next hdc, hdc in next 17 (19, 19,

21) hdc, 2 hdc in next hdc, hdc in next 7 (8, 8, 9) hdc, 2 hdc in next hdc, hdc in next 14 (15, 15, 16) hdc, 2 hdc in next hdc, hdc in next 7 (8, 8, 9) hdc, 2 hdc in next hdc, hdc in last 7 (8, 8, 9) hdc—103 (113, 113, 123) hdc.

**Sizes 1 Year (2 Years, 4 Years) Only**

**Row 8** Ch 2, turn; hdc in next 8 (8, 9) hdc, 2 hdc in next hdc, hdc in next 9 (9, 10) hdc, 2 hdc in next hdc, hdc in next 16 (16, 17) hdc, 2 hdc in next hdc, hdc in next 9 (9, 10) hdc, 2 hdc in next hdc, hdc in next 19 (19, 21) hdc, 2 hdc in next hdc, hdc in next 9 (9, 10) hdc, 2 hdc in next hdc, hdc in next 16 (16, 17) hdc, 2 hdc in next hdc, hdc in next 9 (9, 10) hdc, 2 hdc in next hdc, hdc in last 9 (9, 10) hdc—121 (121, 131) hdc.

**Size 4 Years Only**

**Row 9** Ch 2, turn; hdc in next 9 hdc, 2 hdc in next hdc, hdc in next 11 hdc, 2 hdc in next hdc, hdc in next 18 hdc, 2 hdc in next hdc, hdc

in next 11 hdc, 2 hdc in next hdc, hdc in next 23 hdc, 2 hdc in next hdc, hdc in next 11 hdc, 2 hdc in next hdc, hdc in next 18 hdc, 2 hdc in next hdc, hdc in next 11 hdc, 2 hdc in next hdc, hdc in last 10 hdc—139 hdc.

**All Sizes**

Begin Fancy Stitch Pattern.

**Row 1** (set-up row—right side) Ch 3, turn; sc in first hdc, [sk next 2 hdc, (2 dc, ch 2, 2 dc) in next hdc (shell made), sk next 2 hdc, (sc, ch 3, sc) in next hdc] 1 (2, 2, 3) times, sk next 2 hdc, shell in next hdc, sk next hdc, (sc, ch 3, sc) in next hdc, sk next hdc, shell in next hdc, sk next 2 hdc, (sc, ch 3, sc) in next hdc, [sk next 2 hdc, shell in next hdc, sk next 2 hdc, (sc, ch 3, sc) in next hdc] 3 times, sk next hdc, shell in next hdc, sk next 2 hdc, (sc, ch 3, sc) in next hdc, [sk next 2 hdc, shell in next hdc, sk next 2 hdc, (sc, ch 3, sc) in next hdc] 4 (5, 5, 6) times, sk next 2 hdc, shell in next hdc, sk next hdc, (sc, ch 3, sc) in next hdc, [sk next 2

**SCHEMATIC**

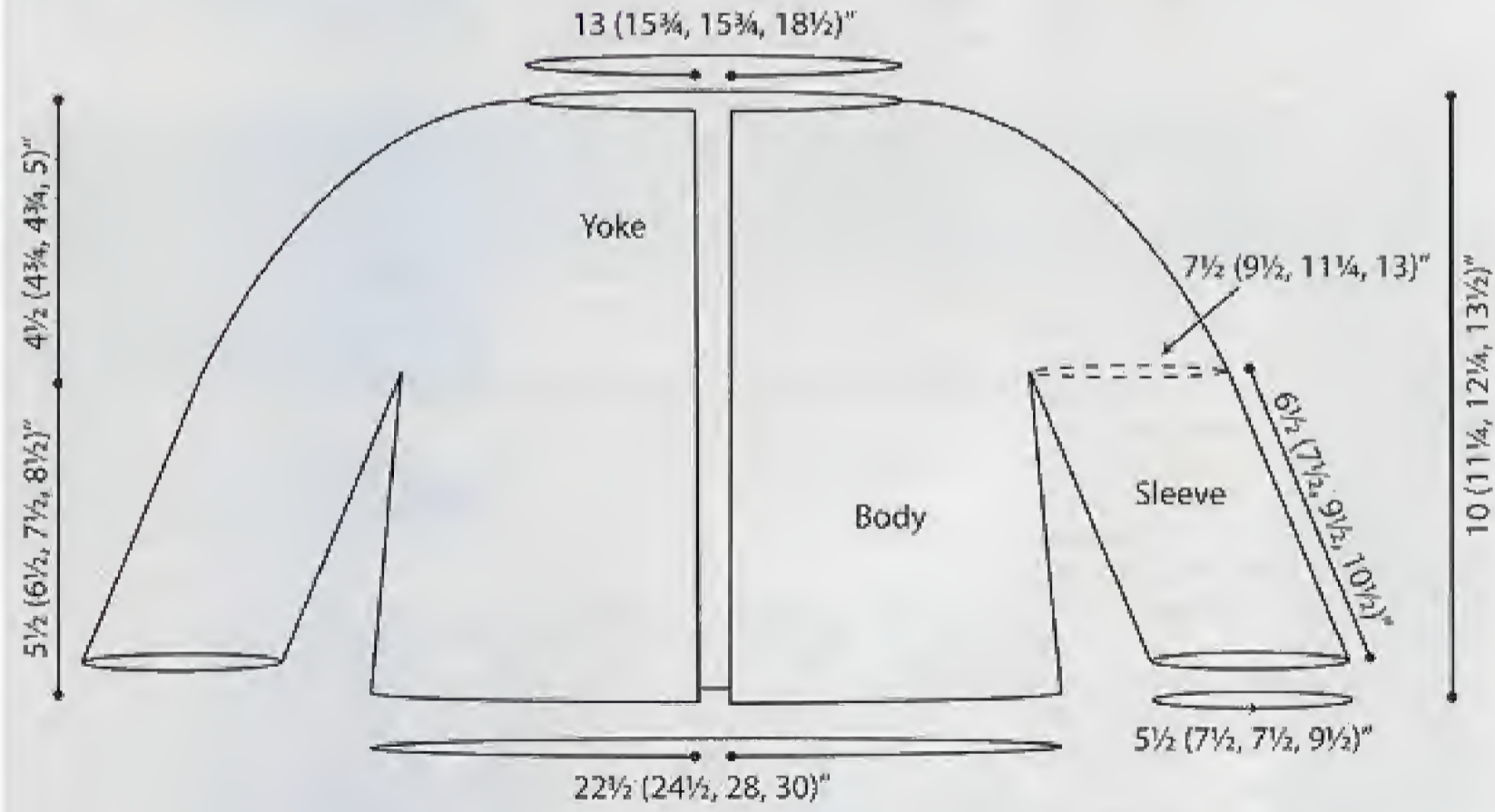



hdc, shell in next hdc, sk next 2 hdc, (sc, ch 3, sc) in next hdc] 3 times, sk next 2 hdc, shell in next hdc, sk next hdc, (sc, ch 3, sc) in next hdc, sk next hdc, shell in next hdc, sk next 2 hdc, (sc, ch 3, sc) in next hdc; [sk next 2 hdc; shell in next hdc, sk next 2 hdc, (sc, ch 3, sc) in next hdc] 0 (1, 1, 2) times, sk next 2 hdc, shell in next hdc, sk next 2 hdc, (sc, ch 1, hdc) in last hdc—16 (21, 21, 24) shells.

Beginning with Row 1 of pattern, work 3 rows of Fancy Stitch Pattern. Do not fasten off.

**Note** You will end with a Row 1 of Fancy Stitch Pattern.

**BODY**

**Note** The front and back sections will now be worked together, leaving stitches unworked for the sleeves (to be added later).

**Row 1** Ch 3 (counts as hdc, ch 1), turn; sc in first dc, [shell in next ch-3 sp, (sc, ch 3, sc) in ch-2 sp of next shell] twice, shell in next ch-3 sp, ch 3 (3, 9, 9) (for underarm), sk next 3 (4, 4, 5) ch-3 sps, [shell in next ch-3 sp, (sc, ch 3, sc) in ch-2 sp of next shell] 5 (6, 6, 7) times, shell in next ch-3 sp, ch 3 (3, 9, 9) (for underarm), sk next 3 (4, 4, 5) ch-3 sps, [shell in next ch-3 sp, (sc, ch 3, sc) in ch-2 sp of next shell] twice, shell in last ch-3 sp, (sc, ch 1, hdc) in top of turning ch—12 (13, 13, 14) shells and 2 ch-3 sps (for underarms).

**Sizes 6 Months (1 Year) Only**

**Row 2** Ch 3 (counts as dc), turn; 2 dc in first hdc; [(sc, ch 3, sc) in ch-2 sp of next shell, shell in next ch-3 sp] twice, (sc, ch 3, sc) in ch-2 sp of next shell, sk next ch, shell in next ch, sk next ch, [(sc, ch 3, sc) in ch-2 sp of next shell, shell in next ch-3 sp] 5 (6) times, (sc, ch 3, sc) in next ch-2 sp, sk next ch, shell in next ch, sk next ch, [(sc, ch 3, sc) in ch-2 sp of next shell, shell in next ch-3 sp] twice, (sc, ch 3, sc) in ch-2 sp of last shell, 3 dc in 2nd ch of turning ch—12 (13) shells (counting beginning and ending dc-groups as 1/2 shell each).

**Sizes 2 Years (4 Years) Only**

**Row 2** Ch 3 (counts as dc), turn; 2 dc in first hdc, [(sc, ch 3, sc) in ch-2 sp of next shell, shell in next ch-3 sp] twice, (sc, ch 3, sc) in ch-2 sp of next shell, sk next ch, shell in next

ch, sk next 2 ch, (sc, ch 3, sc) in next ch, sk next 2 ch, shell in next ch, sk next ch, [(sc, ch 3, sc) in ch-2 sp of next shell, shell in next ch-3 sp] 6 (7) times, (sc, ch 3, sc) in next ch-2 sp, sk next ch, shell in next ch, sk next 2 ch, (sc, ch 3, sc) in next ch, sk next 2 ch, shell in next ch, sk next ch, [(sc, ch 3, sc) in ch-2 sp of next shell, shell in next ch-3 sp] twice, (sc, ch 3, sc) in ch-2 sp of last shell, 3 dc in 2nd ch of turning ch—15 (16) shells (counting beginning and ending dc-groups as 1/2 shell each).

**All Sizes**

Beginning with Row 2 of pattern, work 8 (10, 12, 14) rows of Fancy Stitch Pattern.

**Note** You will end with a Row 1 of Fancy Stitch Pattern.

**Last Row** Ch 1, turn; sc in first dc, ch 2, 2 sc in next ch-3 sp, ch 2, \*2 sc in ch-2 sp of next shell, ch 2, 2 sc in next ch-3 sp, ch 2; repeat from \* across, sc in top of turning ch. Fasten off.

**SLEEVE (WORK 2)**

**Note** Sleeves are worked in the round without turning. Do not turn at the end of rounds.

**Sizes 6 Months (1 Year) Only**

**Round 1** (right side) With right side facing and beginning along opposite side of underarm ch, sk first ch, join A with sl st in next ch, ch 3 (counts as dc), dc in same ch, sk next ch, (sc, ch 3, sc) in ch-2 sp of next shell, \*shell in next ch-3 sp, (sc, ch 3, sc) in ch-2 sp of next shell; repeat from \* around, 2 dc in same ch as join, hdc in top of turning ch (join forms ch-2 sp and completes shell)—4 (5) shells.

**Sizes 2 Years (4 Years) Only**

**Round 1** (right side) With right side facing and

beginning along opposite side of underarm ch, sk first ch, join A with sl st in next ch, ch 3 (counts as dc), dc in same ch, sk next 2 ch, (sc, ch 3, sc) in next ch, sk next 2 ch, shell in next ch, sk next ch, (sc, ch 3, sc) in ch-2 sp of next shell, \*shell in next ch-3 sp, (sc, ch 3, sc) in ch-2 sp of next shell; repeat from \* around, 2 dc in same ch as join; join with hdc in top of turning ch (join forms ch-2 sp and completes shell)—6 (7) shells.

**All Sizes**

**Round 2** Ch 1, sc in first ch-2 sp (formed by join), shell in next ch-3 sp, \*(sc, ch 3, sc) in ch-2 sp of next shell, shell in next ch-3 sp; repeat from \* around, sc in same sp as first sc; join with ch 1, hdc in first sc (join forms ch-3 sp).

**Round 3** Ch 3 (counts as dc), dc in first ch-3 sp (formed by join), (sc, ch 3, sc) in ch-2 sp of next shell, \*shell in next ch-3 sp, (sc, ch 3, sc) in ch-2 sp of next shell; repeat from \* around, 2 dc in same sp as first dc; join with hdc in top of turning ch (join forms ch-2 sp and completes shell). Repeat last 2 rounds 0 (0, 0, 1) more time(s), then repeat Round 2 once more.

**Shape Sleeve**

**Round 1** Ch 3 (counts as dc), (sc, ch 3, sc) in ch-2 sp of next shell, \*shell in next ch-3 sp,

*Tip*  
The top-down construction of this little sweater allows you to try it on your baby as you work.

**STITCH DIAGRAM**

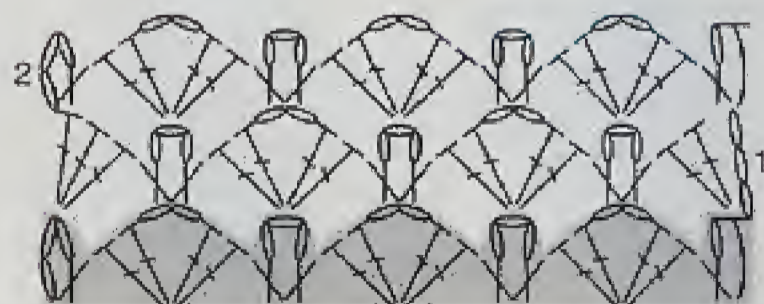



(sc, ch 3, sc) in ch-2 sp of next shell; repeat from \* around, dc in same sp as first dc; join with hdc in top of beginning ch (join forms ch-2 sp).

**Round 2** Ch 1, sc in first ch-2 sp (formed by join), shell in next ch-3 sp, \*(sc, ch 3, sc) in ch-2 sp of next shell, shell in next ch-3 sp; repeat from \* around; join with sl st in first sc.

**Round 3** Sl st in first 2 dc of first shell, ch 1, (sc, ch 3, sc) in ch-2 sp of same shell, shell in next ch-3 sp, (sc, ch 3, sc) in ch-2 sp of next shell, \*shell in next ch-3 sp, (sc, ch 3, sc) in ch-2 sp of next shell; repeat from \* around; join with sl st in first sc.

**Round 4** Sl st in first 2 ch of first ch-3 sp, ch 3 (counts as dc), (sc, ch 3, sc) in ch-2 sp of next shell, shell in next ch-3 sp; \*(sc, ch 3, sc) in ch-2 sp of next shell, shell in next ch-3 sp; repeat from \* around, dc in same ch-3 sp as first sl st; join with hdc in top of beginning ch (join forms ch-2 sp).

**Round 5** Ch 1, sc in first ch-2 sp (formed by join), shell in next ch-3 sp, (sc, ch 3, sc) in ch-2 sp of next shell, \*shell in next ch-3 sp, (sc, ch 3, sc) in ch-2 sp of next shell; repeat from \* around; join with sl st in first sc.

**Round 6** Sl st in first 2 dc of first shell, (sl st, ch 1, sc) in ch-2 sp of same shell, shell in next ch-3 sp, \*(sc, ch 3, sc) in ch-2 sp of

next shell, shell in next ch-3 sp; repeat from \* around, sc in same sp as first sc; join with ch 1, hdc in first sc (join forms ch-3 sp)—3 (4, 5, 6) shells.

Repeat last 6 rounds 0 (0, 1, 1) more time(s), ending with Round 6 (6, 12, 12)—3 (4, 4, 5) shells.

**Round 7 (7, 13, 13)** Ch 3 (counts as dc), dc in first ch-3 sp (formed by join), (sc, ch 3, sc) in ch-2 sp of next shell, \*shell in next ch-3 sp, (sc, ch 3, sc) in ch-2 sp of next shell; repeat from \* around, 2 dc in same sp as first dc; join with hdc in top of turning ch (join forms ch-2 sp and completes shell).

**Round 8 (8, 14, 14)** Ch 1, sc in first ch-2 sp (formed by join), shell in next ch-3 sp, \*(sc, ch 3, sc) in ch-2 sp of next shell, shell in next ch-3 sp; repeat from \* around, sc in same sp as first sc; join with ch 1, hdc in first sc (join forms ch-3 sp).

**Round 9 (9, 15, 15)** Repeat Round 7 (7, 13, 13).

Repeat last 2 rounds 0 (1, 0, 0) more time(s).

**Last Round** Ch 1, sc in first ch-2 sp (formed by join), ch 2, 2 sc in next ch-3 sp, ch 2, \*2 sc in ch-2 sp of next shell, ch 2, 2 sc in next ch-3 sp, ch 2; repeat from \* around, sc in same sp as first sc; join with sl st in first sc. Fasten off.

## FINISHING

### Cuff Edging

**Round 1** With right side facing, join B with sc in any sc of Last Round of sleeve, sc in each sc and ch around; join with sl st in first sc.

**Round 2** Ch 1, sc in each sc around; join with sl st in first sc. Fasten off.

### Body Edging

**Round 1** With right side facing, join B with sc in sc of lower edge at back, sc in each sc and ch all the way around all edges of body, working 3 sc in outside corners, and skipping 1 st on inside corners; join with sl st in first sc.

Place a marker on right front edge about  $\frac{3}{4}$ "/2cm above beginning of Fancy Stitch Pattern. Place a second marker about halfway between the first marker and the neck edge.

**Round 2** Ch 1, sc in each sc around, working 3 sc in outside corners, skipping 1 st on inside corners, and working ch 4 for buttonholes at each marker; join with sl st in first sc.

Fasten off.

Weave in all ends. With matching thread, sew buttons to left front, opposite button holes. With B, work a line of surface slip st where the hdc yoke meets the Fancy Stitch Pattern (for decoration).





# Cotton Candy Blanket



Baby Clouds in Blue Sky

Give baby a taste of the sweet life with this snugly, warm blanket. Stitched in soft, lofty yarn, it's fluffy as a cloud and warm as can be!

By Ellen K. Gornley



## What You'll Need

### YARN

RED HEART Baby Clouds, 6oz/170g skeins, each approx 140yd/128m (acrylic)

1 skein each:

- #9025 Blue Sky (A)
- #9381 Pale Blue (B)
- #9311 Cloud (C)

### CROCHET HOOK

- Size N/15 (10mm) crochet hook or any size to obtain correct gauge

### NOTIONS

- Yarn needle

Skill Level: Easy

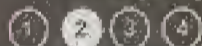

## ABBREVIATIONS USED IN THIS PATTERN

ch(s) chain(s)      sl st slip stitch  
dc double crochet      sp(s) space(s)  
sc single crochet      st(s) stitch(es)  
sk skip

[ ] Work directions inside brackets as many times as indicated.

( ) Work directions inside parentheses into st or sp indicated.

\* Repeat directions following \* as many times as indicated.

### SPECIAL ABBREVIATIONS

FPtr (Front Post treble crochet) Yarn over twice, insert hook from front to back to front around post of indicated st, yarn over and draw up a loop, [yarn over and draw through 2 loops on hook] 3 times.

## FINISHED MEASUREMENTS

Approx 38"796.5cm x 38"796.5cm

## GAUGE

Rounds 1-3 = 7"18cm square. Remember to check gauge for best results! If necessary, adjust hook size to obtain correct gauge.

## BLANKET

With A, ch 5, join with sl st to form a ring.

**Round 1** (right side) Ch 4 (counts as dc and ch-1 sp here and throughout), [dc in ring, ch-1] 7 times; join with sl st in 3rd ch of beginning ch-4—8 dc and 8 ch-1 sps. Fasten off.

**Round 2** With right side facing, join B with sl st in any ch-1 sp, ch 4, (dc, ch 3, dc, ch 1, dc) in same ch-1 sp as joining, \*ch 1, dc in next ch-1 sp, ch 1\*\*, (dc, ch 1, dc, ch 3, dc, ch 1, dc) in next ch-1 sp; repeat from \* 3 more times; ending last repeat at \*\*; join with sl st in 3rd ch of beginning ch-4—20 dc, 4 corner ch-3 sps and 16 ch-1 sps. Fasten off.

**Round 3** With right side facing, join C with sl st in any corner ch-3 sp, ch 4, (dc, ch 3, dc, ch 1, dc) in same ch-3 sp as joining, \*ch 1, dc in next ch-1 sp] 4 times, ch 1\*\*, (dc, ch 1, dc, ch 3, dc, ch 1, dc) in next corner ch-3 sp; repeat from \* 3 more times, ending last repeat at \*\*; join with sl st in 3rd ch of beginning ch-4—32 dc, 4 corner ch-3 sps, and 28 ch-1 sps. Fasten off.

**Round 4** With right side facing, join B with sl st in any corner ch-3 sp, ch 4, (dc, ch 3, dc, ch 1, dc) in same ch-3 sp as joining, \*ch

1, [dc in next ch-1 sp, ch 1, FPtr around dc 1 row directly below next ch-1 sp, ch 1] 3 times, dc in next ch-1 sp, ch 1\*\*, (dc, ch 1, dc, ch 3, dc, ch 1, dc) in next corner ch-3 sp; repeat from \* 3 more times, ending last repeat at \*\*; join with sl st in 3rd ch of beginning ch-4—32 dc, 12 FPtr, 4 corner ch-3 sps, and 40 ch-1sps. Fasten off.

**Round 5** With right side facing, join A with sl st in any corner ch-3 sp, ch 6 (counts as dc and ch-3 sp here and throughout), dc in same ch-3 sp as joining, \*ch 1, dc in next ch-1 sp; repeat from \* across to next corner ch-3 sp, ch 1\*\*, (dc, ch 3, dc) in next corner ch-3 sp; repeat from \* 3 more times, ending last repeat at \*\*; join with sl st in 3rd ch of beginning ch-6—48 dc, 4 corner ch-3 sps, and 44 ch-1 sps. Fasten off.

**Round 6** With B, repeat Round 5—52 dc, 4 corner ch-3 sps, and 48 ch-1 sps. Fasten off.

**Round 7** With C, repeat Round 5—56 dc, 4 corner ch-3 sps, and 52 ch-1 sps. Fasten off.

**Round 8** With right side facing, join B with sl st in any corner ch-3 sp, ch 3 (counts as dc here and throughout), 4 dc in same ch-3 sp as joining, \*ch 3, sk next ch-1 sp, \*\*dc in next ch-1 sp, ch 1, FPtr around dc 1 row directly below next ch-1 sp, ch 1; repeat from \*\* across to last 2 ch-1 sps before next corner ch-3 sp, dc in next ch-1 sp, ch 3, sk next ch-1 sp\*\*, 5 dc in next corner ch-3 sp; repeat from \* 3 more times, ending last repeat at \*\*; join with sl st in 3rd ch of beginning ch-3—44 dc, 20 FPtr, 8 ch-3 sps.







and 40 ch-1 sps. Fasten off.

**Round 9** With right side facing, join A with sl st in first dc of 5 dc in any corner, ch 8 (counts as dc and ch-5 sp here and throughout), sk next 3 dc, dc in next dc, \*ch 1, dc in next ch-3 sp, \*\*ch 1, dc in next ch-1 sp; repeat from \* across to next ch-3 sp, ch 1, dc in next ch-3 sp, ch 1\*\*, dc in next dc, ch 5, sk next 3 dc, dc in next dc; repeat from \* 3 more times, ending last repeat at \*\*; join with sl st in 3rd ch of beginning ch-8—56 dc, 4 corner ch-5 sps, and 52 ch-1 sps. Fasten off.

**Round 10** With right side facing, join B with sl st in any corner ch-5 sp, ch 4, (dc, ch 3, dc, ch 1, dc) in same ch-5 sp as joining, \*ch 1, dc in next ch-1 sp; repeat from \* across to next corner ch-5 sp, ch 1\*\*, (dc, ch 1, dc, ch 3, dc, ch 1, dc) in next corner ch-5 sp; repeat from \* 3 more times, ending last repeat at \*\* join with sl st in 3rd ch of beginning ch-4—68 dc, 4 corner ch-3 sps, and 64 ch-1

sps. Fasten off.

**Round 11** Repeat Round 7—72 dc, 4 corner ch-3 sps, and 68 ch-1 sps.

**Round 12** Repeat Round 8—52 dc, 26 FPtr, 8 ch-3 sps, and 56 ch-1 sps.

**Round 13** Repeat Round 9—72 dc, 4 corner ch-5 sps, and 68 ch-1 sps.

**Round 14** Repeat Round 10—84 dc, 4 corner ch-3 sps, and 80 ch-1 sps.

**Round 15** Repeat Round 7—88 dc, 4 corner ch-3 sps, and 84 ch-1 sps.

**Round 16** With C, repeat Round 8—60 dc, 36 FPtr, 8 ch-3 sps, and 72 ch-1 sps.

**Round 17** Repeat Round 9—88 dc, 4 corner ch-5 sps, and 84 ch-1 sps.

**Round 18** With C, repeat Round 10—100 dc, 4 corner ch-3 sps, and 96 ch-1 sps.

**Round 19** Repeat Round 5—104 dc, 4 corner ch-3 sps, and 100 ch-1 sps.

**Round 20** With A, repeat Round 8—68 dc, 44 FPtr, 8 ch-3 sps, and 88 ch-1 sps.

**Round 21** With right side facing, join C with

sc in 3rd dc of 5 dc in any corner, 2 sc in same st as joining, \*sc in each st, sc in each ch-1 sp and 3 sc in each ch-3 sp across to middle dc of 5 dc in next corner\*\*, 3 sc in middle dc; repeat from \* 3 more times, ending last repeat at \*\*; join with sl st in first sc—232 sc. Fasten off.

#### FINISHING

Weave in all ends...

#### Tip

To help differentiate right side from wrong side, insert a stitch marker or safety pin in any stitch on the right side.







STITCH DIAGRAM

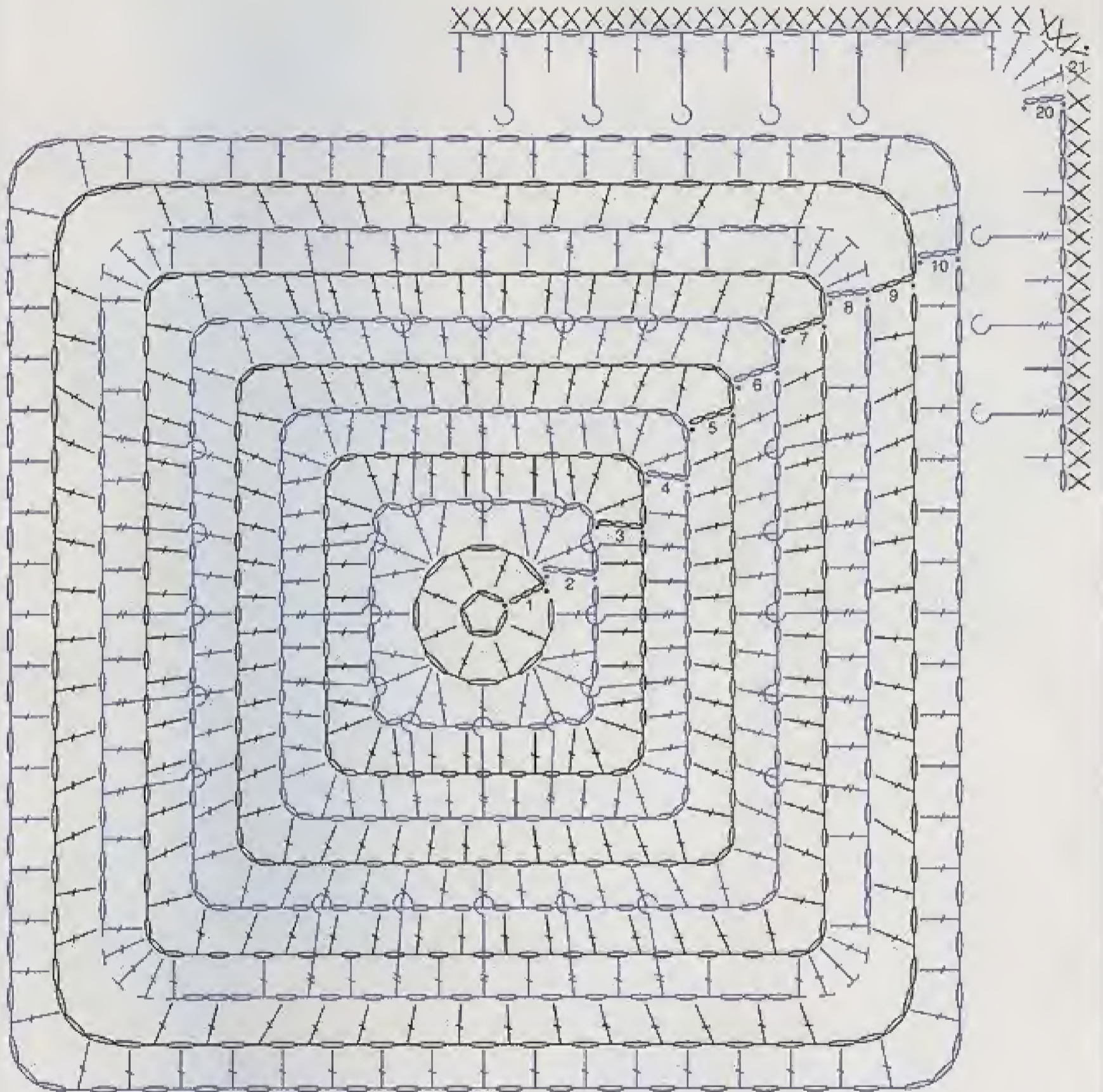



# Gumdrop Booties

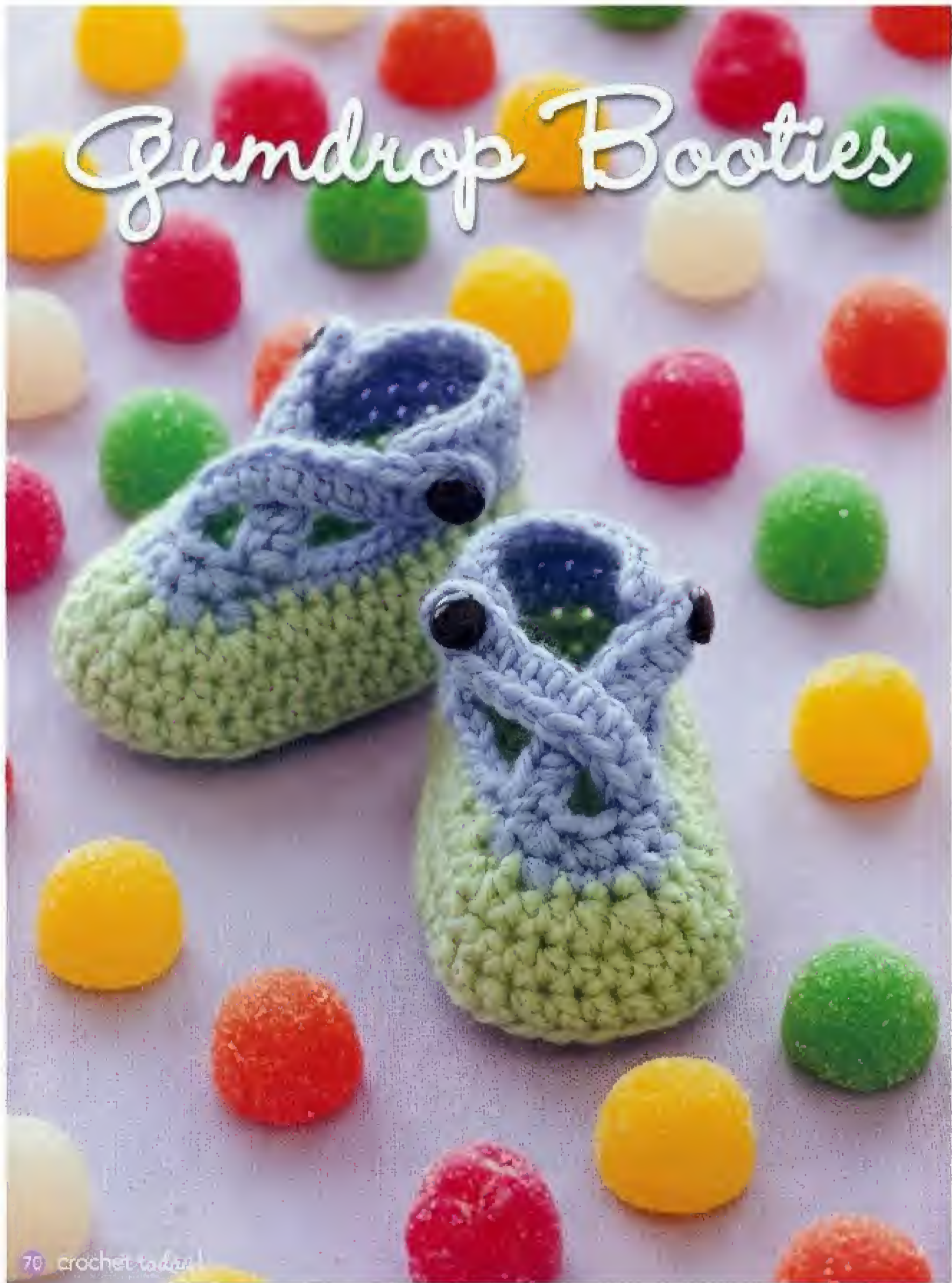



Tiny feet are truly sweet in these adorable booties. You can whip up these cute confections in less than an hour each!

By Robyn Chachula

## What You'll Need

### YARN

RED HEART Soft Baby Steps, 5oz/142g balls, each approx. 256yds/234m (acrylic)  
1 ball each:

- #9620 Baby Green (A)
- #9800 Baby Blue (B)

### CROCHET HOOK

- Size H/8 (5mm) crochet hook or any size to obtain correct gauge

### MATERIALS

- 4 buttons—7/16" x 11mm
- 4 small snaps
- Sewing needle and matching thread
- Yarn needle

Skill Level: Intermediate



## KEEPING UP WITH THIS PATTERN

**ch** chain      **sl st** slip stitch  
**hdc** half double crochet      **sp(s)** space(s)  
**sc** single crochet      **st(s)** stitch(es)  
**sk** skip

[ ] Work directions in brackets number of times indicated.

### SC2TOG (single crochet 2 stitches together)

[insert hook in next st; yarn over and draw up a loop] twice, yarn over and draw through all 3 loops on hook.

**hdc2tog** (half double crochet 2 stitches together) [Yarn over insert hook in next st, yarn over and draw up a loop] twice, yarn over and draw through all 5 loops on hook.

## SIZES

3 (6, 9) months

## FINISHED MEASUREMENTS

length 3½ (4, 4½)"/9 (10, 11.5)cm

width 2¼"/5.5cm (for all sizes)

## GAUGE

Use finished measurements for gauge. Remember to check gauge for best results!

## BOOTIE (MAKE 2)

With A, ch 12 (13, 14).

**Note** Do not turn at end of rounds.

**Round 1** (right side) Hdc in 3rd ch from hook (beginning ch counts as hdc), hdc in each remaining ch across to last ch, 3 hdc in last ch; pivot to work along opposite side of foundation ch, hdc in each ch across; join with sl st in top of beginning ch—22 (24, 26) hdc.

**Round 2** Ch 2 (counts as hdc here and throughout), 2 hdc in next hdc, hdc in next 8 (9, 10) hdc, 2 hdc in next 3 hdc, hdc in next 8 (9, 10) hdc, 2 hdc in next hdc, hdc in same st as join; join with sl st in top of beginning ch—28 (30, 32) hdc.

**Round 3** Ch 1, sc in same st as join, sc in next hdc, 2 sc in next hdc, sc in next 9 (10, 11) hdc, 2 sc in next hdc, sc in next 4 hdc, 2 sc in next hdc, sc in next 9 (10, 11) hdc, 2 sc in next hdc; join with sl st in first sc—32 (34, 36) sc.

**Round 4** Ch 1, sc in next 2 sc, 2 sc in next sc, sc in next 9 (10, 11) sc, hdc in next sc, 2 hdc in next sc, hdc in next 2 sc, 2 hdc in next 2 sc; hdc in next 2 sc, 2 hdc in next sc, hdc in next sc, sc in next 9 (10, 11) sc, 2 sc in next sc; join with sl st in first sc—38 (40, 42) sts.

**Round 5** Ch 2, working in back loops only, hdc in each st around; join with sl st in top of beginning ch.

**Round 6** Ch 2, hdc in each hdc around; join with sl st in top of beginning ch.

**Round 7** Ch 2, hdc in next 14 (15, 16) hdc, hdc2tog, hdc in next 2 hdc, [hdc2tog] twice, hdc in next 2 hdc, hdc2tog, hdc in next 7 (8, 9) hdc, place marker in hdc just made, hdc

Make a pair for a baby girl in #9700 Baby Pink and #9590 Lavender



in each remaining hdc around; join with sl st in top of beginning ch—34 (36, 38) hdc. Fasten off.

**Round 8** Join B with sc in marked hdc, sc in next 17 (19, 21) hdc, [sc2tog] twice, sc in next 2 hdc, [sc2tog] twice, sc in each remaining hdc around; join with sl st in first sc—30 (32, 34) sc.

## Back of Bootie

**Row 9** Ch 1, sc in next 12 (14, 16) sc; leave remaining sts unworked.

**Row 10** Ch 1, turn, sc in next 12 (14, 16) sc.

**Row 11** Ch 2, turn, hdc in each sc across. Fasten off.

## STRAPS (MAKE 1 PER BOOTIE)

With B, ch 11.

**Row 1** Hdc in 3rd ch from hook, hdc in each remaining ch across, with right side of bootie facing, join to bootie with sc in 6th unworked sc following back of bootie, working in sts across toe of bootie [sc2tog] 3 times, sc in next sc, ch 11, hdc in 3rd ch from hook, hdc in each remaining ch across. Fasten off and weave in ends.

## FINISHING

With right side facing and sewing needle and thread, sew one snap closure in each upper corner of back of bootie and wrong side of straps. Sew button to right side of straps for decoration.

the yarn



Soft Baby Steps in Baby Green



# Candy Store Set



Moon & Stars in Limeade

Pretty pastels and super-soft yarn make the perfect scarf and mitten pair. Stitch this candy-colored set for the little one on your gift list!

By Ellen K. Gormley



## What You'll Need

### YARN

- RED HEART Moon & Stars, 1 3/4oz/50g balls, each approx 110yd/100m (scr/yllc/nylon)
- 2 balls #3624 Limeade (A)
- 1 ball #3001 Snow (B)
- 1 ball #3588 Violet (C)

### CROCHET HOOK

- Size G/6 (4mm) crochet hook or any size to obtain correct gauge

### NOTIONS

- Stitch markers
- Yarn needle

Skill Level: Easy

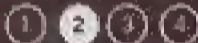

## ABBREVIATIONS USED IN THIS PATTERN

- |    |                |       |             |
|----|----------------|-------|-------------|
| ch | chain          | sk    | skip        |
| dc | double crochet | sl st | slip stitch |
| sc | single crochet | st(s) | stitch(es)  |
- [ ] Work directions in brackets number of times indicated.

## SPECIAL ABBREVIATION

- sc2tog** (single crochet 2 sts together) [insert hook in next st, yarn over and draw up a loop] twice, yarn over and draw through all 3 loops on hook.

## FINISHED MEASUREMENTS

**scarf** approx 4"10cm wide and 38"96.5cm long

**mittens** approx 7 3/4"19.5cm circumference (at widest) and 7 1/2"19cm long (to fit children 4-7 years old)

## GAUGE

15 sts and 15 rows = 4"10cm over sc  
Remember to check gauge for best results!

## HOW TO MAKE A GAUGE SWATCH

With A, ch 16.

**Row 1** Sc in 2nd ch from hook and in each remaining ch across—15 sc.

**Rows 2-15** Ch 1, turn; sc in each st across. Resulting gauge swatch should measure approx 4 x 4"10 x 10cm. If necessary, adjust hook size to obtain correct gauge.

## NOTES

**1** To change color, work last stitch of old color to last yarn over; yarn over with new color and draw through all loops on hook to complete the stitch. Drop the old color and continue working with the new color. Do not fasten off old color until instructed to do so.

**2** To carry a color not in use, work the stitches of the current color over the strand of the color not in use.

**3** When working in rounds, always work the first stitch into the same stitch as the join.

## SCARF

With A, ch 16.

**Row 1** Sc in 2nd ch from hook and in each remaining ch across—15 sc.

**Rows 2-8** Ch 1, turn; sc in each sc across, change to B in last st of Row 8. Do not fasten off A. Carry A along beneath stitches of B.

**Row 9** With B, ch 1, turn; sc in each sc across, change to C in last st. Do not fasten off B. Carry B along beneath stitches of C. Leave A on this edge.

**Row 10** With C, ch 1, turn; sc in each sc across, change to B in last st. Fasten off C.

**Row 11** With B, ch 1, turn; sc in each st across, change to A in last st. Fasten off B.

**Rows 12-19** With A, ch 1, turn; sc in each st across, change to B in last st of Row 19. Do not fasten off A. Carry A along beneath stitches of B.

**Rows 20-140** Repeat Rows 9-19, 11 more times. Fasten off.

## MITTEN (MAKE 2)

Beginning at top of mitten with A, ch 2.

**Round 1** Work 6 sc in 2nd ch from hook; join with sl st in first sc—6 sc.

**Round 2** Ch 1, 2 sc in next 2 sc, sc in next sc, 2 sc in next 2 sc, sc in next sc; join with sl st in first sc—10 sc.

**Round 3** Ch 1, sc in next sc, 2 sc in next 2 sc, sc in next 3 sc, 2 sc in next 2 sc, sc in next 2





crochet today! 73



sc; join with sl st in first sc—14 sc.

**Round 4** Ch 1, sc in next 2 sc, 2 sc in next 2 sc; sc in next 5 sc, 2 sc in next 2 sc, sc in next 3 sc; join with sl st in first sc—18 sc.

**Rounds 5–7** Ch 1, sc in each sc around; join with sl st in first sc.

**Round 8** Ch 1, [sc in next 5 sc, 2 sc in next sc] 3 times; join with sl st in first sc—21 sc.

**Rounds 9 and 10** Ch 1, sc in each sc around; join with sl st in first sc.

**Rounds 11–13** Ch 1, 2 sc in next sc, sc in each remaining sc around; join with sl st in first sc—24 sc at end of Round 13.

**Round 14** Ch 1, sc in each sc around; join with sl st in first sc.

**Round 15** Ch 1, sc in next sc, ch 7 (for thumb), sk next 2 sc, sc in each remaining sc around; join with sl st in first sc—22 sc and 1 ch-7 sp.

**Round 16** Ch 1, sc in next sc, 7 sc in next ch-7 sp; sc in each remaining sc around; join with sl st in first sc—29 sc.

**Rounds 17 and 18** Ch 1, sc in each sc around; join with sl st in first sc.

**Round 19** Ch 1, sc2tog, sc in next 10 sc, sc2tog, sc in last 15 sc; join with sl st in first sc—27 sc.

**Round 20** Ch 1, sc2tog, sc in next 9 sc, sc2tog, sc in last 14 sc; join with sl st in first sc—25 sc.

**Round 21** Ch 1, [sc2tog, sc in next 6 sc] 3 times, sc in last sc and change to B; join with sl st in first sc—22 sc. Fasten off A.

**Round 22** With B, sc2tog, sc in each sc around to last 2 sc, sc2tog and change to C; join with sl st in first sc—20 sc.

**Round 23** With C, repeat Round 22, change to B in last st—18 sc. Fasten off C.

**Round 24** With B, repeat Round 22, do not change color in the st—16 sc. Fasten off B.

#### Thumb

**Note** Thumb is worked in a continuous spiral. Do not join rounds. Place a marker in the first st of the first round, to indicate the beginning

of the round, and move the marker up as each round is completed.

**Round 1** Join A with sc in any st in thumb opening, work 12 more sc evenly spaced around opening; do not join—13 sc.

**Round 2** Sc in each sc around.

**Rounds 3–7** Sc2tog, sc in each remaining sc around—8 sc at the end of Round 7.

**Round 8** [Sc2tog] 4 times; join with sl st in first sc—4 sc. Fasten off.

#### Cuff

With A, ch 6.

**Row 1** Sc in 2nd ch from hook and in each remaining ch across—5 sc.

**Rows 2–16** Ch 1, turn; working in back loops only, sc in each sc across. Fasten off.

#### Tie (Make Only 1)

With B, ch 125. Fasten off. Join A with sc in first ch, sc in each remaining ch across—125 sc. Fasten off leaving a 4"/10cm tail for sewing.

#### FINISHING

Weave in all ends. Sew short edges of cuff together. Whipstitch one long edge of cuff to last round of mitten. Repeat to join cuff to other mitten.

With yarn needle, whipstitch one end of tie to cuff of one mitten on the opposite side from the thumb. Whipstitch the other end of the tie onto cuff of other mitten (also opposite thumb).



*Thread the mitten's long cord through the sleeves of your kid's winter coat, and the mittens will never go missing!*



# All Wrapped Up

**S**how you care this holiday season with handmade gifts guaranteed to keep their recipient warm and cozy. Gloves, scarves, slippers and more will warm heart and soul, this holiday season and for years to come.



A cozy blanket P86



# Twirly Scarf

Stitch this flirty scarf for the ladies on your list—we think it's a perfect fit for anyone from little girls to grandmas!

By Erin Slonaker

## What You'll Need

### YARN

RED HEART Artesano, 3½oz/100g balls, each approx 187yd/172m (acrylic/nylon)

- 1 ball #4376 Caribe

### CROCHET HOOK

- Size I/9 (5.5mm) crochet hook or any size to obtain correct gauge

### NOTIONS

- Yarn needle

Skill Level: Easy

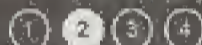

### ABBREVIATIONS USED IN THIS PATTERN

ch(s) chain(s)      sc single crochet  
dc double crochet    st(s) stitch(es)  
hdc half double crochet

\* Repeat directions following \* as many times as indicated.

### FINISHED MEASUREMENTS

Approx 78" / 198cm long

### GAUGE

Gauge is not critical for this project. The finished scarf will be approximately the same length as the foundation chain when fully stretched.

### SCARF

Ch 253.

**Row 1** Sc in 2nd ch from hook and in each remaining ch across—252 sc.

**Row 2** Ch 2 (counts as first hdc), turn; hdc in next 2 sc, 2 hdc in next sc, \*hdc in next 3 sc, 2 hdc in next sc; repeat from \* across—315 hdc.

**Row 3** Ch 3 (counts as first dc), turn; dc in next hdc, 2 dc in next hdc, \*dc in next 2 hdc, 2 dc in next hdc; repeat from \* across—420 dc.

**Rows 4 and 5** Ch 1, turn; \*2 sc in next st, sc in next st; repeat from \* across—945 sc.

Fasten off.

### FINISHING

Weave in all ends...



## Tip

When a turning chain counts as a stitch, do not work into the first stitch of the previous row, unless instructed to do so.

the yarn



Artesano in Caribe.



try this!

The spirals would be just as lovely made in Artesano in #4374 Merlot or #4372 Purple Mist.



### STITCH DIAGRAM

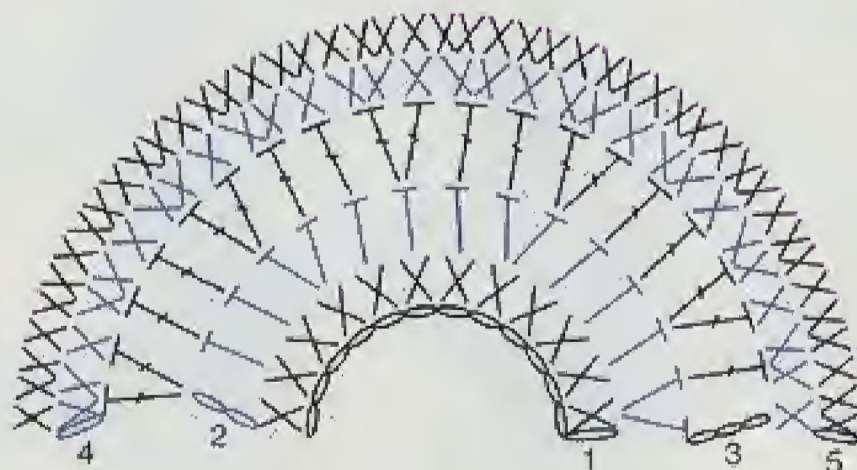







# Two-Hour Hat



Need a quick gift for the guys on your list? This simple cap is sure to suit almost any man's style, and you can whip it up in no time flat.

By Linda Permann

## What You'll Need

### YARN

RED HEART Collage, 3½oz/100g balls, each approx 218yd/200m (acrylic)

- 1 ball #2352 Crimson Maple

### TOOLS & MORE

- Size J/10 (6mm) crochet hook or any size to obtain correct gauge

### NOTES

- Yarn needle

Skill Level: Beginner

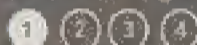

## ABBREVIATIONS USED IN THIS PATTERN

ch(s) chain(s)      sc single crochet

## the yarn



Collage in  
Crimson Maple



## try this!

Neutrals make for great hats; try Collage in #2407 Ice Storm or #2934 Tundra



## FINISHED SIZE

Approx 21"⁄53.5cm circumference; stretches to fit most men's heads

## GAUGE

14 sc and 15 rows worked in back loop = 4"⁄10cm square

Remember to check gauge for best results!

## HOW TO MAKE A GAUGE SWATCH

Ch 15.

**Row 1** Sc in 2nd ch from hook and in each remaining ch across—14 sc.

**Rows 2–15** Ch 1, turn; working in back loops, sc in each sc across. Resulting gauge swatch should measure approx 4"⁄10cm square. If necessary, adjust hook size to obtain correct gauge.

## HAT

Ch 32, leaving an 18"⁄45.5cm tail for sewing.

**Row 1** (wrong side) Sc in 2nd ch from hook and in each remaining ch across—31 sc.

**Row 2** Ch 1, turn; working in back loops, sc in first 30 sc, leaving last sc unworked—30 sc.

**Row 3** Ch 1, turn; working in back loops, sc in

each sc across—30 sc.

**Row 4** Ch 1, turn; working in back loops, sc in each sc across, sc in unworked sc 3 rows below—31 sc.

**Row 5** Repeat Row 3—31 sc.

**Rows 6–72** Repeat Rows 2–5, 16 more times, then repeat Rows 2–4 once more. At end of last row, fasten off, leaving an 18"⁄45.5cm tail for sewing.

## FINISHING

With right sides together, thread tail in and out of each hole created by unworked sc and pull taut to gather top of hat. Secure tail. Whipstitch first and last rows together to form side seam. Weave in ends. Turn right side out.

## Tip

For a larger or smaller hat, work more or fewer rows. For a shorter hat, work fewer foundation chains and fewer sc in each row.

## STITCH DIAGRAM

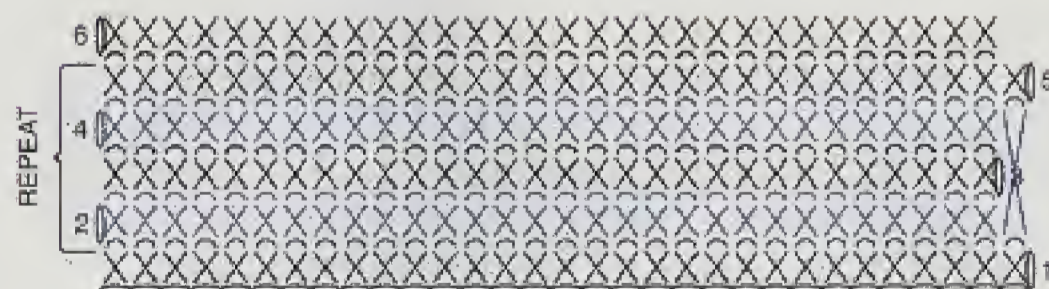





rechet today! 79





...~\*~\*~ Chilly mornings are more fun with a pair of these cute slippers!



# Snuggly Slippers

Keep your toes cozy this winter with our take on the classic pompom slipper sock.

By Linda Permann



## What You'll Need

### YARN

TLC Essentials, 6oz/170g skeins, each approx 312 yd/285m (acrylic)  
1 skein each:

- #2332 Linen (A)
- #2883 Country Blue (B)
- #2254 Persimmon (C)

**Note** You should be able to make at least three pairs of slippers from these quantities.

### CROCHET HOOKS

- Size J/10 (6mm) crochet hook or any size to obtain correct gauge
- Size I/9 (5.5mm) crochet hook or any size to obtain correct gauge

### NOTIONS

- 1 1/2 5cm piece of heavy cardboard or small pompom maker
- Yarn needle

Skill Level: Easy



## ABBREVIATIONS USED IN THIS PATTERN

**ch** chain                      **sc** single crochet  
**dc** double crochet        **sl st** slip stitch  
**hdc** half double crochet **st(s)** stitch(es)

[ ] Work directions in brackets number of times indicated.

\* Repeat directions following \* as many times as indicated.

## SPECIAL ABBREVIATIONS

**3-dc Cl** (3 double crochet cluster) Yarn over, insert hook in next st, yarn over and draw up a loop, yarn over and draw through 2 loops on hook; [yarn over, insert hook in same st, yarn over and draw up a loop, yarn over and draw through 2 loops on hook] 2 times; yarn over and draw through all 4 loops on hook.

**sc2tog** (single crochet 2 stitches together) [insert hook in next st, yarn over and draw up a loop] twice, yarn over and draw through all 3 loops on hook.

## FINISHED MEASUREMENTS

Soles measure approx 9 (10, 11)"/23 (25.5, 28)cm long, to fit shoe sizes 3-6 (6-9, 9-12)

## GAUGE

10 sts and 12 rows = 4"/10cm over single crochet worked with larger hook and 2 strands of yarn held together

12 sts and 16 rows = 4"/10cm over single crochet worked with smaller hook and a single strand of yarn.

*Remember to check gauge for best results!*

## HOW TO MAKE A GAUGE SWATCH

With larger hook and 2 strands of yarn held together, ch 11.

**Row 1** Sc in 2nd ch from hook and in each remaining ch across—10 sc.

**Rows 2-12** Ch 1, turn; sc in each st across. Resulting gauge swatch should measure approx 4 x 4"/10 x 10cm. If necessary, adjust hook size to obtain correct gauge.

## NOTES

**1** If you'd like to make the slippers in a single color, one skein will be enough to make at least one pair of slippers.

**2** The slipper upper is worked more tightly so that the slipper will not stretch out of shape after use.

**3** The sole is worked with two strands of yarn held together, and the upper is worked with a single strand of yarn.

## SOLE (MAKE 2)

With larger hook and 2 strands of A held together, ch 15 (18, 21).

**Round 1** (right side) 2 sc in 2nd ch from hook, sc in next 12 (15, 18) ch; 4 sc in last ch; rotate piece to work along opposite side of foundation ch, sc in next 12 (15, 18) ch, 2 sc in last ch; join with sl st in first sc—32 (38, 44) sc.

**Round 2** Ch 1, 2 sc in next 2 sc, sc in next 11 (14, 17) sc, hdc in next sc, 2 dc in next 4 sc, hdc in next sc, sc in next 11 (14, 17) sc, 2 sc in last 2 sc; join with sl st in first sc—40 (46, 52) sts.

**Round 3** Ch 1, [sc in next st, 2 sc in next st] 2 times, sc in next 10 (13, 16) sts, hdc in next st, [dc in next st, 2 dc in next st] 5 times, hdc in next st, sc in next 10 (13, 16) sts, [sc in next st, 2 sc in next sts] 2 times; join with sl st in first sc—49 (55, 61) sts.

**Round 4** Ch 1, [sc in next 2 sts, 2 sc in next st] 2 times, sc in next 14 (17, 20) sts, 2 sc in next 9 sts, sc in next 14 (17, 20) sts, [sc in next 2 sts, 2 sc in next st] 2 times; join with sl st in first sc—62 (68, 74) sts. Fasten off.

## the yarn

Essentials in Country Blue



## Tip

These little slippers make perfect stocking stuffers!





**Note** The narrower end is for the heel, the wider end for the toe.

**UPPER**

With right side facing down and smaller hook, join one strand of B by drawing up a loop in join at heel.

**Round 1** Ch 1, working in back loops only, sc in each sc around; join with sl st in first sc—62 (68, 74) sc.

**Round 2** Ch 1, sc in next 19 (22, 25) sc, [sc in next sc, sc2tog] 8 times, sc in last 19 (22, 25) sc; join with sl st in first sc—54 (60, 66) sc.

**Rounds 3–5** Ch 1, sc in each sc around; join with sl st in first sc.

**Round 6** Ch 1, sc in first 18 (21, 24) sc, [sc in next sc, sc2tog] 6 times, sc in last 18 (21, 24) sc; join with sl st in first sc—48 (54, 60) sc.

**Round 7** Ch 1, [sc2tog] 2 times, sc in next 14

(17, 20) sc, [sc in next sc, sc2tog] 4 times, sc in next 14 (17, 20) sc, [sc2tog] 2 times; join with sl st in first sc—40 (46, 52) sc. Drop B from hook, but do not fasten off.

With wrong side (inside of slipper) facing, join one strand of C by drawing up a loop in join of previous round.

**Round 8** (wrong side) With C, ch 1, \*sc in next 3 sc, 3-dc Cl; repeat from \* around to last 0 (2, 0) sts, sc in last 0 (2, 0) sts; join with sl st in first sc—10 (11, 13) clusters. Gently push clusters to right side of slipper. Fasten off C. Pick up B and resume working with right side facing.

**Round 9** (right side) With B, ch 1, sc in each st around; join with sl st in first sc.

Fasten off B.

With right side facing, join one strand of A by drawing up a loop in join of previous round.

**Round 10** With A, sl st in each sc around. Fasten off.

**FINISHING**

Weave in all ends.

**POMPOMS (MAKE 2—OPTIONAL)**

Following package directions of pompom maker, or working as follows, make two pompoms. Wrap C around 1 1/2 2.5cm piece of cardboard (the more wraps, the fuller the pompom will be). With yarn needle, thread a 6 7/15cm strand of C under yarn at top edge of cardboard and tie into a tight knot. Cut strands of yarn at opposite end of piece of cardboard. Fluff and trim pompom to make a pompom about 1 1/2 4cm in diameter. Sew one pompom to center back of each slipper.



**try this!**

Change the main color to #2533 Dark Plum or #2675 Dark Thyme







*Tip - Wrap these gloves with a bottle of hand lotion to make a great gift!*

# Gifty Gloves

No fussy left and right hand instructions here—these gloves are made identically, and one is turned inside out! The slip stitches make this pattern fully reversible.

By Kj Hay

crochet today! 83



## What You'll Need

### YARN

RED HEART Heart & Sole, 1½oz/50g balls, each approx 213yd/195m (super-wash wool/nylon)

- 2 balls #3945 Rustica

### CROCHET HOOK

- Size D/3 (3.25mm) crochet hook or any size to obtain correct gauge.

### NOTIONS

- 4 buttons— $\frac{3}{8}$ "/9mm diameter
- Stitch markers
- Yarn needle

Skill Level: Easy



### ABBREVIATIONS USED IN THIS PATTERN

ch(s) chain(s)      sl st slip stitch

hdc half double crochet      st(s) stitch(es)

sk skip

[ ] Work directions inside brackets as many times as indicated.

( ) Work directions inside parentheses into stitch indicated.

\* Repeat directions following \* as many times as indicated.

### FINISHED MEASUREMENTS

Approx 8½"/20.5cm long and 9"/23cm around at widest point

### GAUGE

24 sts and 30 rows = 4"/10cm; over pattern stitch (alternating sl st and hdc)

*Remember to check gauge for best results!*

### HOW TO MAKE A GAUGE SWATCH

Ch 25.

**Row 1** Work same as Row 1 on glove—24 sts.

**Rows 2–30** Work same as Row 2 on glove.

Resulting gauge swatch should measure approx 4"/10cm square. *If necessary, adjust hook size to obtain correct gauge.*

### NOTES

**1** Leave long tails when fastening off near fingers. Use tails to close any small holes between fingers.

**2** Take care when working the alternating half double crochet and slip stitch pattern. The thin, variegated yarn can make the slip stitches a bit difficult to see. Take care to work slip stitches loosely, and count the number of stitches in each row or round.

**3** The buttons and button loops were intended to be worn on the inside of the wrist, but you may prefer the buttons on the outside.

### GLOVE (MAKE 2)

Beginning at cuff, ch 39.

**Row 1** (right side) Sl st in 2nd ch from hook, hdc in next ch, \*sl st in next ch, hdc in next ch; repeat from \* across—38 sts.

**Rows 2–10** Ch 1, turn; \*sl st in next hdc, hdc in next sl st; repeat from \* across.

**Row 11** Ch 7, turn; sl st in 2nd ch from hook and in next 5 chs (button loop started),

\*sl st in next hdc, hdc in next sl st; repeat from \* across.

**Row 12** Repeat Row 2. Do not work any sts into button loop at end of row. Place a marker at beginning of this row for button placement.

**Row 13** Ch 1, turn; inserting hook through lip of button loop and into first hdc, work a sl st (button loop completed), hdc in next sl st, \*sl st in next hdc, hdc in next sl st; repeat from \* across.

**Row 14** Repeat Row 2.



**Rows 15–17** Repeat Rows 11–13. Place a marker at beginning of Row 16 for button placement.

**Rows 18–22** Repeat Row 2, 5 more times. Place markers in 9th and 30th st on Row 22.

**Note** When you reach a marker, remove marker, work stitch(es) into marked stitch as instructed, then replace marker in stitch indicated or in stitch worked.

**Row 23** Ch 1, turn; \*sl st in next hdc, hdc in next sl st; repeat from \* across to next marker, (sl st, hdc, sl st) in marked st, move marker to last sl st made, \*hdc in next sl st, sl st in next hdc; repeat from \*\* across to next marker, (hdc, sl st, hdc) in marked st, move marker to 2nd to last hdc made, \*\*\*sl st in next hdc, hdc in next sl st; repeat from \*\*\* across—42 sts.

**Row 24** Ch 1, turn; (sl st, hdc, sl st) in next hdc, \*hdc in next sl st, sl st in next hdc; repeat from \* across to last sl st, (hdc, sl st, hdc) in last sl st—46 sts.

**Row 25** Repeat Row 23—50 sts. Remove markers.

### Join to Work in the Round

**Round 26** Repeat Row 24; join with sl st in first sl st—54 sts.

**Round 27** Ch 1, turn; \*sl st in next hdc, hdc in next sl st; repeat from \* around; join with sl st in first sl st.

Repeat Round 27 until piece measures about 5½"/14cm from beginning, ending by working a wrong side row.

### Divide for Thumb

**Round 1** (right side) Ch 1, turn; (sl st in next hdc, hdc in next sl st) 5 times, ch 3 (thumb

the yarn



Heart & Sole in Rustica







dividing chain), sk next 13 sts, hdc in next sl st, \*sl st in next hdc, hdc in next sl st; repeat from \* around; join with sl st in first sl st—44 sts (including 3 chs).

**Round 2** Ch 1, turn; (sl st in next hdc, hdc in next sl st) 15 times, sl st in next hdc, hdc in next ch; sl st in next ch, hdc in next ch, (sl st in next hdc, hdc in next sl st) 5 times; join with sl st in first sl st.

**Round 3** Ch 1, turn; \*sl st in next hdc, hdc in next sl st; repeat from \* around; join with sl st in first sl st.

Repeat Round 3 until piece measures approximately 13 2/3 cm from beginning of thumb divide, ending by working a wrong side row.

**Divide for Pinky**

**Round 1** (right side) Ch 1, turn; (sl st in next hdc, hdc in next sl st) 14 times, sl st in next hdc, ch 2 (pinky dividing chain); sk next 10 sts, hdc in next sl st, (sl st in next hdc, hdc in next sl st) 2 times; join with sl st in first sl st—36 sts (including 2 chs).

**Round 2** Ch 1, turn; (sl st in next hdc, hdc in next sl st) 2 times, sl st in next hdc, hdc in next ch, sl st in next ch, hdc in next sl st, (sl st in next hdc, hdc in next sl st) 14 times; join with sl st in first sl st.

**Rounds 3 and 4** Ch 1, turn; \*sl st in next hdc, hdc in next sl st; repeat from \* around; join with sl st in first sl st.

**Divide for Ring, Middle, and Index Fingers**

**Round 1** (right side) Ch 1, turn; (sl st in next hdc, hdc in next sl st) 3 times, ch 2 (index finger dividing chain), sk next 12 sts, (sl st in next hdc, hdc in next sl st) 3 times, ch 2 (ring finger

dividing chain), sk next 12 sts; join with sl st in first sl st—16 sts (including 4 chs).

**Complete Middle Finger**

**Round 2** Ch 1, turn; \*sl st in next ch, hdc in next ch, (sl st in next hdc, hdc in next sl st) 3 times; repeat from \* once more; join with sl st in first sl st.

**Rounds 3–7** Ch 1, turn; \*sl st in next hdc, hdc in next sl st; repeat from \* around; join with sl st in first sl st. Fasten off.

**Complete Thumb**

With right side facing, join yarn with sl st in first skipped hdc after thumb dividing chain.

**Round 1** Working in all sts and free loops along opposite side of dividing chain, hdc in next st, \*sl st in next st, hdc in next st; repeat from \* around; join with sl st in first sl st—16 sts.

**Rounds 2–5** Ch 1, turn; \*sl st in next hdc, hdc in next sl st; repeat from \* around; join with sl st in first sl st. Fasten off.

**Complete Pinky, Ring, and Index Fingers**

With right side facing, join yarn with sl st in first skipped hdc after dividing chain on Pinky, Ring, or Index Finger.

**Rounds 1–5** Work same as Rounds 1–5 on Thumb—12 sts on Pinky, 14 sts on Ring and Index Fingers. Fasten off.

Repeat for other 2 fingers.

**FINISHING**

Turn one glove inside out (for other hand). On each glove, sew two buttons on marked rows, opposite button loops.

Weave in ends.



**Tip**

If you prefer complete fingers on your gloves, continue to work the last round of the thumb and fingers until desired length. Fasten off, leaving a long tail. Thread the tail through the stitches of the last round, pull tight to close top of finger, and weave in the end.



Blankets  
make great gifts  
that will be used  
for years!





# Wrap-Up Afghan

Cuddle up on a cold winter's day with this sweet blanket. It's sure to become a new favorite, whether you make it as a gift for yourself or for someone you love.

By Vickie Howell

## What You'll Need

### YARN

RED HEART Soft Yarn, 5oz/140g balls, each approx 286yd/234m (acrylic)

- 3 balls #9114 Honey (A)
- 3 balls #4422 Tangerine (B)
- 3 balls #9520 Seafam (C)
- 2 balls #9518 Teal (D)
- 4 balls #4614 Black (E)

### CROCHET HOOK

- Size I/9 (5.5mm) crochet hook or any size to obtain correct gauge

### NOTIONS

- Yarn needle

Skill Level: Easy

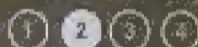

## ABBREVIATIONS USED IN THIS PATTERN

ch(s) chain(s)      sl st slip stitch  
 dc double crochet      sp(s) space(s)  
 hdc half double crochet      st(s) stitch(es)  
 sc single crochet

[ ] Work directions inside brackets as many times as indicated.

( ) Work directions inside parentheses into st or sp indicated.

\* Repeat directions following \* as many times as indicated.

## FINISHED MEASUREMENTS

Approx 43"/109cm x 51½"/131cm

## GAUGE

Square = 8½"/21.5cm square

Remember to check gauge for best results!

## THROW

### Square #1 (Make 10)

With A, ch 6; join with sl st to form a ring.

**Round 1** (right side) Ch 3 (counts as dc here and throughout), 2 dc in ring, (ch 3, 3 dc in ring) 3 times, ch 3; join with sl st in 3rd ch of beginning ch-3—12 dc and 4 corner ch-3 sps. Fasten off.

**Round 2** With right side facing, join B with sl st in any corner ch-3 sp, ch 5 (counts as dc and ch-2 sp here and throughout), \*(3 dc, ch 3, 3 dc) in next corner ch-3 sp, ch 2; repeat from \* 2 more times, (3 dc, ch 3, 2 dc) in first corner ch-3 sp; join with sl st in 3rd ch of beginning ch-5—24 dc, 4 corner ch-3 sps and 4 ch-2 sps.

**Round 3** Sl st in next ch-2 sp, ch 3 (counts as dc here and throughout), 2 dc in same ch-2 sp, \*ch 2, (3 dc, ch 3, 3 dc) in next corner ch-3 sp, ch 2\*, 3 dc in next ch-2 sp; repeat from \* 3 more times, ending last repeat at \*\*; join with sl st in 3rd ch of beginning ch-3—36 dc, 4 corner ch-3 sps and 8 ch-2 sps.

**Round 4** Ch 5, 3 dc in next ch-2 sp, \*ch 2, (3 dc, ch 3, 3 dc) in next corner ch-3 sp\*\*, (ch 2, 3 dc in next ch-2 sp) twice; repeat from \* 3 more times, ending last repeat at \*\*, ch 2, 2 dc in last ch-2 sp; join with sl st in 3rd ch of beginning ch-5—48 dc, 4 corner ch-3 sps and 12 ch-2 sps. Fasten off.

**Round 5** With right side facing, join C with sl st in next ch-2 sp, ch 3, 2 dc in same ch-2 sp as joining, ch 2, 3 dc in next ch-2 sp, \*ch 2,

(3 dc, ch 3, 3 dc) in next corner ch-3 sp\*\*, (ch 2, 3 dc in next ch-2 sp) 3 times; repeat from \* 3 more times, ending last repeat at \*\*, ch 2, 3 dc in last ch-2 sp, ch 2; join with sl st in 3rd ch of beginning ch-3—60 dc, 4 corner ch-3 sps, and 16 ch-2 sps. Fasten off.

**Round 6** With right side facing, join D with sl st in same ch as joining, ch 1, sc in same ch as joining, sc in each dc, 2 sc in each ch-2 sp, and 3 sc in each corner ch-3 sp around; join with sl st in first sc—104 sc. Fasten off.

**Round 7** With right side facing, join E with sl st in any sc, ch 3, dc in next sc and in each sc around, working (dc, ch 1, dc) in middle sc of 3 sc in each corner; join with sl st in 3rd ch of beginning ch-3—108 dc and 4 corner ch-1 sps.

**Round 8** Ch 3, dc in each dc around, working (dc, ch 1, dc) in each corner ch-1 sp; join with sl st in 3rd ch of beginning ch-3—112 dc and 4 corner ch-1 sps. Fasten off.

### Square #2 (Make 10)

Work same as Square #1 with the following color sequence: D, C, B, A, E.

### Square #3 (Make 10)

Work same as Square #1 with the following color sequence: B, A, D, C, E.

## ASSEMBLY

Following Assembly Chart, arrange squares into 5 rows with 6 squares in each row as follows: With right sides of 2 squares together, using E and working through both thicknesses, sl st in both loops of each sl across squares, starting and ending at corner ch-1 sps. Join all squares together into rows. Join rows together in same manner.

the yarn



Soft Yarn in Tangerine







**EDGING**

With right side facing, join A with sl st in any corner ch-1 sp, ch 2 (counts as hdc), 2 hdc in same ch-sp as joining, \*hdc in each st and in each square joining across to next corner\*\*, 3 hdc in next corner ch-1 sp; repeat from \* 3 more times, ending last repeat at \*\*: join with sl st in 2nd ch of beginning ch-2. Fasten off.

**FINISHING**

Weave in all ends. Block if necessary.



**ASSEMBLY DIAGRAM**

1	2	3	1	2
3	1	2	3	1
2	3	1	2	3
1	2	3	1	2
3	1	2	3	1
2	3	1	2	3

**STITCH DIAGRAM**

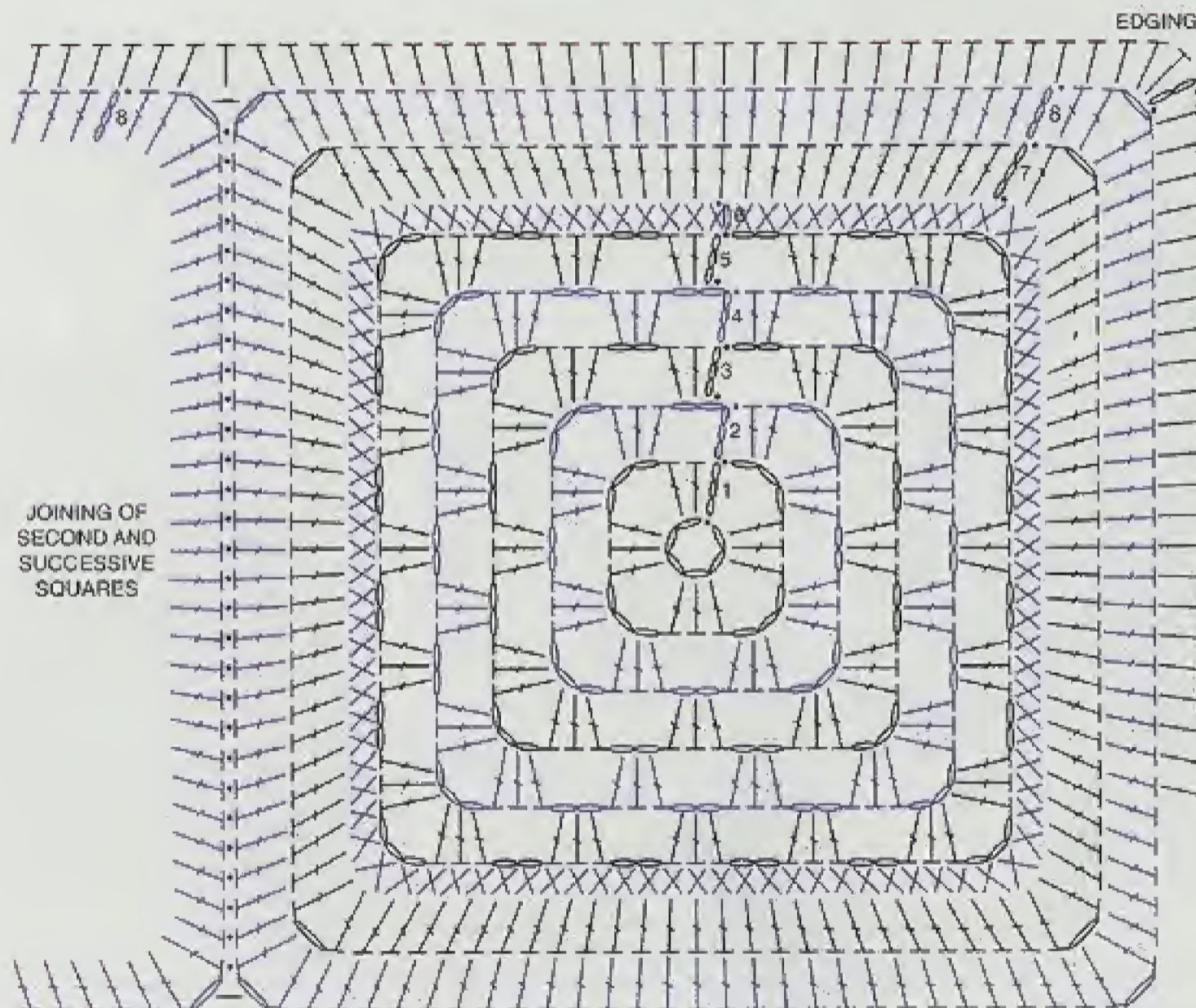



# Projects in this issue

Crochet Today  
Nov/Dec 2009

